

# Solar photovoltaic systems technical training manual

Herbert A. Wade

Illustrated by  
Gloria McConnaghy

Renewable Energies series



UNESCO PUBLISHING

**Renewable Energies series**

UNESCO TOOLKIT OF LEARNING AND TEACHING MATERIALS

# Solar Photovoltaic Systems Technical Training Manual

Herbert A. Wade

Illustrated by  
Gloria McConnaghy

UNESCO PUBLISHING

*In the same series:*

Geothermal energy

Solar detoxification

Solar photovoltaic project development

The designations employed and the presentation of material throughout this publication do not imply the expression of any opinion whatsoever on the part of UNESCO concerning the legal status of any country, territory, city or area or of its authorities, or concerning the delimitation of its frontiers or boundaries.

The author is responsible for the choice and the presentation of the facts contained in this book and for the opinions expressed therein, which are not necessarily those of UNESCO and do not commit the Organization.

Published in 2003 by the United Nations Educational,  
Scientific and Cultural Organization  
7, place de Fontenoy F-75352 Paris 07 SP  
Typeset by S R Nova Pvt. Ltd., Bangalore, India  
Printed by Jouve

ISBN 92-3-103904-0

© UNESCO 2003

All rights reserved

*Printed in France*

# Preface

Developing countries face an overall situation of limited energy resources and applications, particularly in rural areas, and there is an urgent need to address this situation. Limited energy resources and applications pose a serious constraint and barrier to social and economic development, and present significant challenges and opportunities for renewable energy. Renewable energy sources include biomass, solar energy, wind and hydropower. Many of these energy sources have been used for millennia – the sun and wind in drying and other direct or 'passive' applications, while biomass has been the 'active' staple energy source since our ancestors discovered fire. Moreover, water and wind power have been used as energy sources since the earliest driven machinery. Most recently, the use of solar power in photovoltaic systems has become synonymous with renewable energy at the smaller household level.

Renewable energy is also synonymous with sustainable development and has been linked, more recently, with poverty reduction. While the use of renewable energy is the epitome of sustainability, whether and to what extent such applications will reduce poverty is a more complex question. Solar PV systems are most applicable in rural and remote areas that have no access to electricity grids – places that are often the habitats of poor people in developing countries. But PV systems are very expensive for these people, who also have other priorities such as water, housing and education. Although there are undoubted benefits, a crucial issue in the introduction of PV household systems is the need for suitable financial support systems. If the need for such loan or rental arrangements is not recognized and addressed, the users will undoubtedly face additional burdens. Other forms of renewable energy also require promotion as part of an overall approach to energy sustainability and poverty reduction. These include biomass stoves, ovens and related applications, solar drying, water heating, wind and hydropower – the form of energy chosen depending on the local situation.

Measures to address the problems of global warming and sea-level rise and promote sustainable development have been strongly advocated since the Earth Summit in Rio in 1992, and have cited the development, innovation and utilization of renewable energy technologies as an effective means of addressing these problems. There have been widespread calls for the reduction of greenhouse gas emissions, highlighting the importance of domestic actions and the benefits of encouraging renewable energy and energy efficiency. This was again a focus of the World Summit on Sustainable Development in Johannesburg in 2002, with renewable energy forming a component of the WEHAB agenda.

The challenge is to translate high-level political commitments into concrete activities that are of benefit to the world as a whole. Fifty years from now, few will doubt the important role that renewable energy plays in sustainable development.

The challenge is how to move towards this future. This toolkit, consisting of two companion volumes – *Solar Photovoltaic Systems: Technical Training Manual* and *Solar Photovoltaic Project Development*, will help us to move in this direction in the field of household PV systems.

I would particularly like to thank Herbert Wade for the development of the toolkit. I would also like to thank my colleague, Tony Marjoram, for his role in bringing this about, and Akio Suzuki, for the development of the UNESCO Renewable Energies series.

**Walter Erdelen**

Assistant Director-General for the Natural Sciences  
UNESCO

# Contents

**Foreword** vii

**Acknowledgements** ix

**Chapter 1: Solar photovoltaic systems** 1

A general description of PV systems comparing them with rainwater collection systems.

**Chapter 2: Electricity** 7

Fundamentals of dc electricity voltage, current, resistance, power and energy. A comparison of dc electricity with water flow.

**Chapter 3: Photovoltaic panels** 21

The characteristics of solar photovoltaic panels and what needs to be done to maximize their output.

**Chapter 4: Controllers** 29

The devices that control the flow of electrical energy to and from the battery. How they work and their characteristics.

**Chapter 5: Batteries** 35

Batteries as used with photovoltaic systems. The different types, their characteristics and their care.

**Chapter 6: Wiring** 47

Selecting the proper wire and connecting the PV components together.

**Chapter 7: Appliances** 65

Appliances for use with solar PV systems for the home.

**Chapter 8: Photovoltaic-powered refrigerators** 73

The basic mechanical refrigeration cycle and how it operates from PV power. Characteristics of PV-powered refrigerators and their care.

**Chapter 9: System sizing** 83

Procedures for sizing PV systems to meet a particular electrical load. The effect of load, solar energy availability, battery characteristics, panel output and system losses on panel size.

**Chapter 10: Maintenance** 95

Keeping PV systems fully operational through preventive and repair maintenance requirements, procedures and scheduling.

**Chapter 11: Troubleshooting and repair** 101

Determining the cause of PV system failures and their repair.

**Glossary** 111

# Foreword

A variety of smaller-scale solar and renewable energy technology applications were developed and promoted in the 1970s and 1980s. These include solar photovoltaic systems for lighting, battery charging, refrigeration, communications and water pumping. Direct or 'passive' solar applications included water heating, crop drying and solar architecture. Wind, used over generations for water pumping and power, was applied to electricity generation. Hydropower was also developed at micro- and mini-hydro level. Improved cooking stoves and ovens enhanced the efficiency and use of biomass resources. More recent technological applications include hybrid systems, energy cogeneration, small-scale distribution systems and solar desalination.

With few models to follow and such a variety of innovative technologies and approaches, it is not surprising that success was equally varied. There was an emphasis on technological hardware rather than the 'software' of innovation, operation and management that was often supply-driven rather than demand- or user-driven. In the case of relatively expensive photovoltaic solar home systems, for example, this included the problems of affordability and the 'front-end loading' costs of PV systems – and the consequent need for financial support through small loans or rental schemes.

Lessons were learned and improved technology and management systems developed. Many developing countries are now looking to expand and enhance the use of technology applications for solar and renewable energy resources. Solar photovoltaic home systems, mainly for household lighting, are a particular area of interest.

Many challenges, constraints and barriers remain, however, to the use of renewable energy and promotion of associated technologies. These include awareness-raising, advocacy, information, communication, management, maintenance and the development of human and institutional resources. Policy and planning frameworks and instruments are required to promote institutional awareness and innovation of renewable energy systems in the public and private sectors.

Awareness-raising and advocacy are necessary to promote renewable energy to policy-makers, planners, the general public, the private sector, schools, the media and other potential stakeholders and interested parties. Advocacy activities include the need to promote solutions to constraints and barriers. Renewable energy technologies are innovations and require conventional and innovative approaches for promotion and support. This includes demonstration pilot projects and the promotion of good practice through networking and centres of excellence. The development and provision of appropriate payment facilities for households, entrepreneurs and small businesses are vital in promoting the use of renewable energy systems.

Information and communication strategies include the need to use 'conventional' materials, information and communication technologies (ICTs) and multimedia approaches to serve an advocacy role in both promoting renewable energy applications and providing learning and teaching materials for education and training. Management and maintenance are required of renewable energy systems in terms of monitoring and evaluation performance, maintenance needs and durability. Maintenance and rehabilitation are required to promote efficiency and sustainability of existing renewable energy systems and the sustainability of new systems.

The development of human and institutional resources is essential to support this process, and education and training at primary, secondary and tertiary levels are of particular importance to demonstrate and promote the concept and use of

renewable energy. This includes projects in science and technology teaching and the use of photovoltaic lighting and other equipment in 'solar schools'. Training in the application, installation and management of solar and renewable energy systems is also vital, as is the need for good learning and teaching materials in this area.

The toolkit consists of two companion volumes – *Solar Photovoltaic Solar Systems: Technical Training Manual* and *Solar Photovoltaic Project Development*. The technical manual, in landscape format, has greater detail, text and graphics. *Solar Photovoltaic Project Development* has no graphics and smaller font text, and is intended more as a text for teachers both to support the technical training manual – making it easy to relate student and teacher materials, and to discuss wider issues relating to project development for solar photovoltaic systems.

The overall objective of this toolkit is to provide comprehensive training material on the innovation, application, installation, operation, monitoring and evaluation, management maintenance and rehabilitation of PV systems as well as providing useful information for advocacy, awareness raising, innovation, policy and planning.

The toolkit has comprehensive technical, educational and geographical coverage. It provides a complete course in PV applications for rural electrification at three levels: instructor, senior technician and field technician.

The toolkit is based on experience gained in the Pacific, where renewable energy was pioneered, and the islands served as a particular 'laboratory' for solar photovoltaics and rural electrification in the 1970s and 1980s. Pacific Island communities face particular problems of small size, remoteness and isolation – by sea on smaller islands and by land on larger islands. Over 75% of Pacific islanders live in small, scattered communities in rural areas and outer islands, and over 70% of islanders, mainly those in rural areas and outer islands, have no access to electricity. The Pacific Islands have a high dependency on imported hydrocarbon fuels – often the major import. As the islanders face threats of global warming and sea-level rise, it is appropriate that recognition is given to the pioneers of renewable energy in the Pacific and the small island states that have such a particular interest and concern in the success of renewable energy and sustainable development.

This toolkit is based on two excellent manuals of training materials produced in the 1980s by Herb Wade, a specialist in PV practice and applications then working with the Pacific Energy Development Programme. That material has long been out of print and Herb has been happy to revise and update it for wider publication and distribution, creating the attractive and useful toolkit we see here. Herb Wade therefore deserves particular thanks and acknowledgement for the preparation and production of this toolkit, as does Gloria McConnaghy for the illustrations.

**Tony Marjoram**  
Basic and Engineering Sciences  
UNESCO



# Acknowledgements

This text is the result of nearly twenty years of providing solar photovoltaics training courses in the Pacific, Asia and Africa with the support of the Pacific Energy Development Programme, the South Pacific Institute for Renewable Energy, JICA, SIDA, WHO, the EU, the Asian Institute of Technology in Bangkok and the Solar Energy Research and Training Center of Naresuan University in Thailand. The text has gone through many revisions, largely due to feedback from students and professionals in the field of PV applications.

In 1985, Mr Peter Johnston, manager of the Pacific Energy Development Programme under the United Nations (Fiji) and Mr Vincent Coutrot, Director of the South Pacific Institute for Renewable Energy (French Polynesia) began a long series of collaborations for training Pacific islanders in solar photovoltaics. The original series of courses and the development of those course materials could not have taken place without their continued personal interest and support as well as the support of their respective institutions. Mr Henri Lai (French Polynesia), Dr Garry Presthus (India), Mr Michel Zaffran (Switzerland), Dr Supachart Chungpaibilpatana (Thailand) and Assoc. Prof. Wattanapong Rakwichian (Thailand) are also acknowledged as having been exceptionally supportive and having contributed to the long process of development that has resulted in this text.

Within UNESCO, Mr Tony Marjoram was instrumental in making the development of this expanded and updated training text possible and his vision, enthusiasm, encouragement and support has been particularly appreciated. The excellent readability of this book is largely due to the efforts of Ms Caroline Lawrence who did a great job of translating my English into the real thing and ensuring that the text is consistent, readable and accurate. I also would like to thank Mr David McDonald of UNESCO who was a genuine pleasure to work with in the publishing of this book.

Thanks is especially given to some 1,000 students who have participated in the PV training programmes given by the author in the Pacific, Africa and Asia. They have greatly contributed to ensuring that the text fits the needs of persons with only a modest technical background and having English as a second language.

**Herbert Wade**  
Bangkok, 2002

# Solar photovoltaic systems

## WHAT IS A SOLAR PHOTOVOLTAIC SYSTEM?

A solar photovoltaic system turns sunlight into electricity. You are going to learn about solar photovoltaic systems so, to make it easier, we will just call them PV systems. The more sun there is, the more electricity is produced by a PV system. When it rains, little electricity is made. At night, no electricity is produced even if the moon seems very bright. Because electricity is usually needed at night, electricity made during sunny days is stored in a battery. Electricity can be drawn from the battery at any time to do useful things such as operate lights, radios and television.

## WATER SYSTEMS AND PV SYSTEMS: A SIMILAR IDEA

Understanding a PV system may seem difficult. Electricity cannot be seen and measurements must be made with complicated instruments. But it is not difficult to understand, really. Electricity flows in wires just like water flows in pipes. So to help in understanding an electrical system, you can compare it with a water system as water flow can be seen and is easily understood.

The water system that acts most like a solar PV system is a rainwater collection system. The amount of water collected changes with the weather. There are days

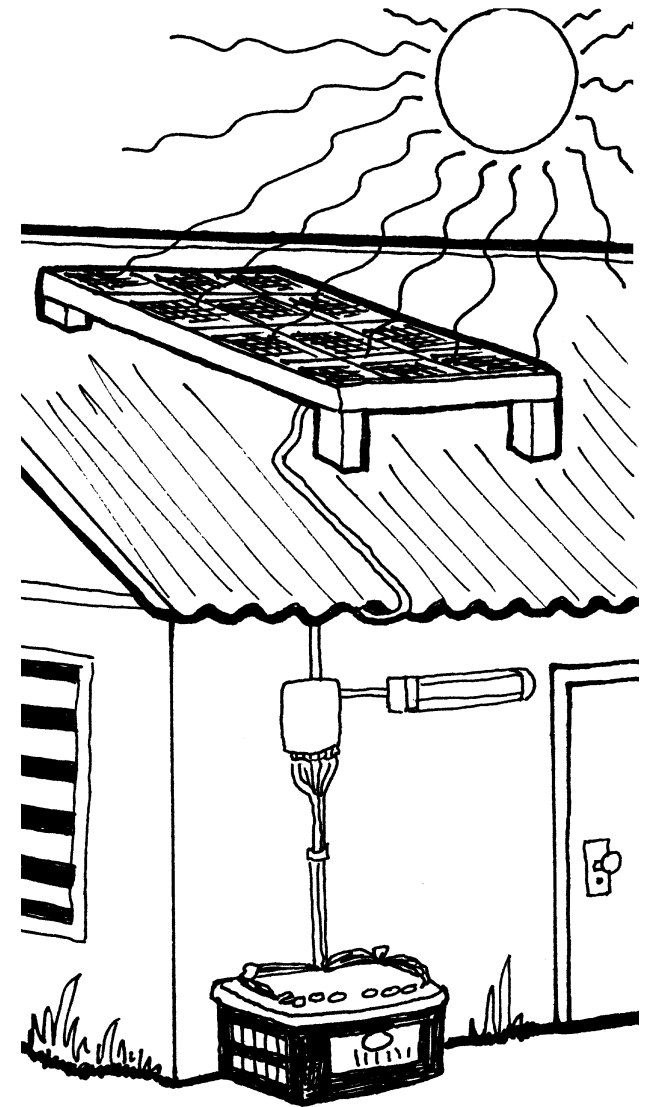

A solar photovoltaic (PV) unit turns sunlight into electricity.

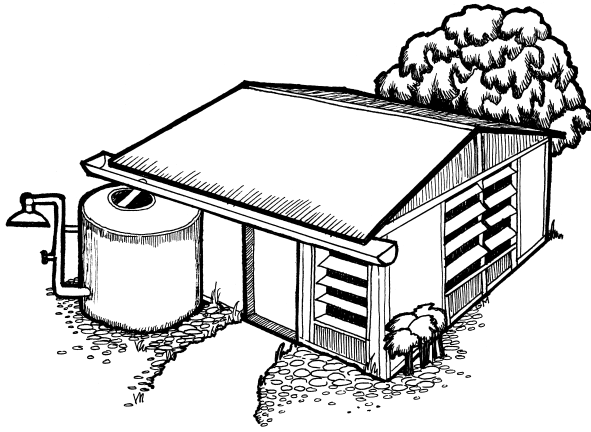

A house with a rainwater system.

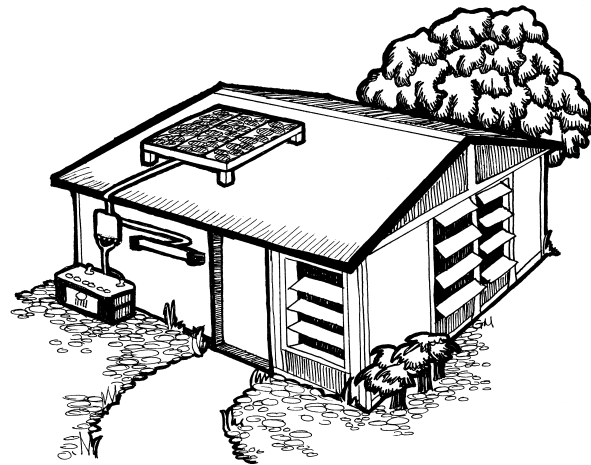

A house with a PV system.

with a lot of rain and days with none, so that some days a lot of water is collected and on others none is collected. In the same way, the amount of electricity collected by a PV system changes according to the weather. There are days with bright sun when a lot of electricity is made and others when it is cloudy and little electricity is made. Sometimes it rains for many days, other times it is dry for many days. Sometimes it is sunny for many days, other times it is cloudy for many days. So the output of both rainwater collection systems and PV systems depends on the patterns of the weather.

Not only do rainwater collection systems and solar PV systems act much the same, they have similar parts.

The main parts of a rainwater system are:

- the roof collection area
- a storage tank
- pipes to carry water to and from the tank
- valves on pipes to control the flow of water
- appliances (such as a shower) to use the water.

The main parts of a PV system are:

- the PV panel
- a storage battery
- wires to carry the electricity to and from the battery
- a controller to control the flow of electricity
- appliances (such as lights) to use the electricity.

Each part of the rainwater system does a similar job to a part in the PV system.

## ■ Collection

The PV panel collects sunlight and converts it into electricity. Sometimes it is mounted on a roof but it can be placed anywhere there is sun. In a rainwater system the part that does a similar job is the house roof. If you think of electricity as being like water, then the solar panel collects sunlight like the roof collects rainwater. The roof collects water that falls from the sky so it can be stored for later use. The solar panel collects sunlight that comes from the sky so it can be stored for later use as electricity. The bigger the roof, the more water collected when it rains. The bigger the solar panel, the more electricity collected during the day. If it rains hard, a lot of water is collected in a short time and if it rains lightly, only a little is collected in the same time. If the sun shines brightly, a lot of electricity is collected in a short time and if it is cloudy, only a little is collected in the same time. If it does not rain, no water is collected. At night, no solar energy is collected. So you see that the idea of using a roof area for collecting rainwater is almost the same as the idea of using a solar panel for collecting energy from the sun.

## ■ Storage

Water is needed when it is not raining and electricity is needed when the sun is not shining. Both a rainwater collection system and a solar PV system must have storage. The battery in a PV system does a job like the storage tank of a water system. The storage tank allows the use of water for some time after it stops raining. The battery allows the use of electricity for some time after the sun goes down.

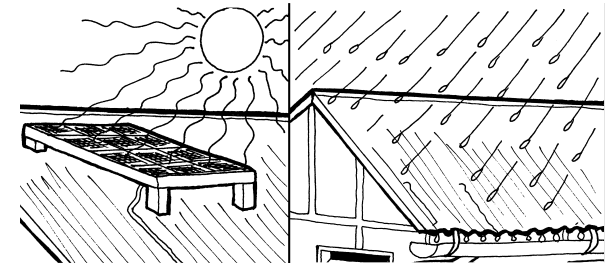

Collecting solar energy and rainwater.

To collect solar energy, a solar panel is used. It is equivalent to the roof in a rainwater system.

To store solar electricity, a battery is used. It is equivalent to the tank in a rainwater system.

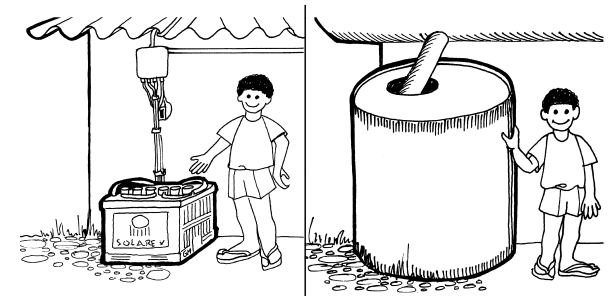

Storage for solar electricity and rainwater.

### SOMETHING VERY IMPORTANT ABOUT PV SYSTEMS

If you use water from the tank faster than rain falling on the roof refills it, the tank will run dry and you will have to wait until it rains again before you have water. If you use electricity faster than the sun shining on the photovoltaic panels can refill the battery then the battery will run out of electricity (discharge). There will be no more electricity for a day or more until the sun can recharge the battery.

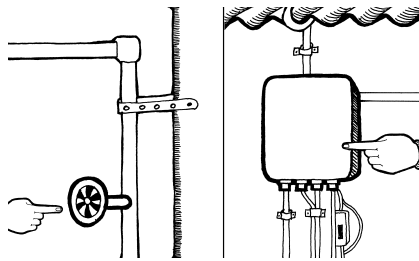

Flow controls for water and electricity.

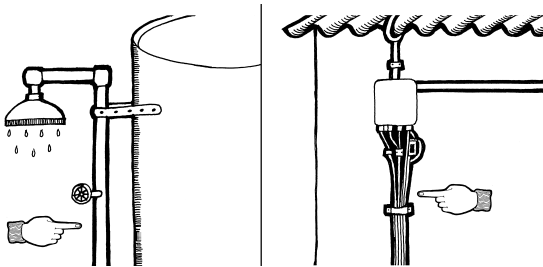

Water is moved through pipes, electricity through wires.

If it rains a lot and no one uses much water, the storage tank fills up to capacity. If the sun shines a lot and there is little use of electricity then the battery becomes full of electricity.

If people use water when there is little rain, the water level in the tank gradually falls and the tank soon empties. If people use electricity when there is little sun, the amount of electricity in the battery gradually falls and soon the battery has no more electricity.

### ■ Flow control

Water storage tanks have valves on their outlet pipes to control the use of water. PV systems have a controller between the battery and appliances to control the use of electricity. Such a controller is called a discharge controller because it controls the amount of electricity coming out of the battery, or discharging. The discharge controller prevents damage to the battery from too much discharge.

Some water storage tanks also have valves on their inlet to prevent them from becoming too full and overflowing. Most PV systems have a controller between the panel and the battery to keep the battery from receiving too much electricity. It is called a charge controller because it controls the amount of energy going into, or charging, the battery. Batteries can be damaged from too much charge, so the charge controller is needed to prevent damage from overcharging.

Usually the charge controller and the discharge controller are combined into one box that is just called a controller.

## ■ Appliances

Various appliances can use water from the rainwater system or electricity from the PV system. In rainwater collection systems, there is often only one appliance attached to the system: a tap. Some water systems may include other appliances such as flush toilets and showers. Appliances that use a lot of water, such as flush toilets, only work well if connected to a water system that is designed for them. If a flush toilet is attached to a water system designed for a simple water tap, it will probably not work well and the storage tank may run dry quickly.

In PV systems, lights are the most common appliances. But it is possible to connect other appliances such as radios, televisions, videos, pumps and even refrigerators if the PV system is designed for them. But if a refrigerator, pump or video is connected to a solar PV system designed only for lights, it will not work well and the battery will discharge quickly.

## ■ Transport

Both water and electricity have to be moved from place to place. To move water from one place to another, pipes are used. To move electricity from one place to another, wires are used. Large pipes let water flow more easily than small pipes, so large pipes are needed when large amounts of water are to be moved quickly. Large wires let electricity flow more easily than small wires and are used when large amounts of electricity are to be moved quickly.

If pipes are not joined together correctly, they leak and all the water does not reach the appliance. If wires are not joined together correctly, all the electricity does not reach the appliance where it is needed.

Wires in a solar PV system are like pipes in a rainwater system.

Appliances are the end users of water in a rainwater system and of electricity in a PV system.



A shower is a water appliance, a light is an electrical appliance.

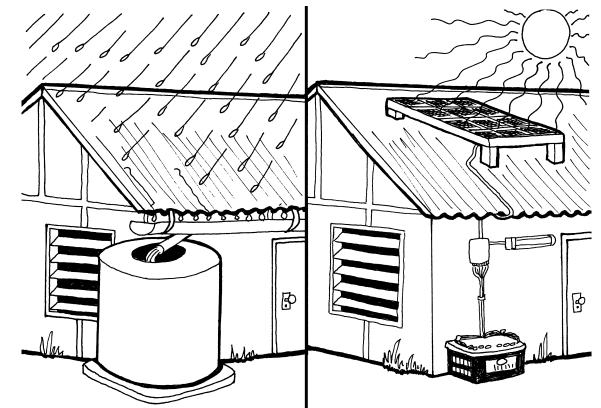

Rainwater system. Photovoltaic system.

**RAINWATER****PV**

Rain	< Source >	Sunlight
Roof	< Collection >	Panels
Valves	< Control >	Controller
Tank	< Storage >	Battery
Pipes	< Transport >	Wires
Appliances	< Use >	Appliances

## SUMMARY

---

Remember that a PV system acts like a rainwater collection system but with electricity instead of water. If you do not understand something about a PV system, think of it as a water system and it will be easier to understand.

# 2 Electricity

## INTRODUCTION

You may have some difficulty understanding electricity because you cannot see it. Fortunately, electricity has many things in common with water so understanding how water acts in a water system helps in understanding how electricity acts in a PV system.

To understand a water system, there are a few things that you should know. Things such as how much water there is, how much force is pushing the water through the pipe and how much water is flowing through the pipe over a certain time. It is important to measure these things in a water system, just as it is to measure similar things in an electrical system.

## PRESSURE

Water pressure is a measure of the force that pushes water through a pipe. Each country has its own method of describing pressure. Units such as pounds per square inch, kilograms per square metre and pascals are used. Although they have different names, they all are a measure of water force. One common measure of water pressure is kilograms per square centimetre ( $\text{kg}/\text{cm}^2$ ). A water pressure measurement of  $\frac{1}{3} \text{ kg}/\text{cm}^2$  is very low and might be found at the outlet to

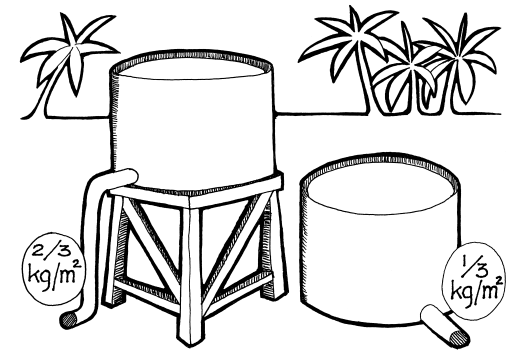

Pressure is the force behind movement of water or electricity. In a water system the pressure increases with tank height.

Water systems and solar systems work in a very similar way. The ideas of pressure, flow rate, volume, resistance to flow, power and energy are almost the same for water and electricity. The problem with electricity is that you cannot see it. But you can see water, therefore in order to better understand an electrical system, you can think of a similar type of water system and how it acts.



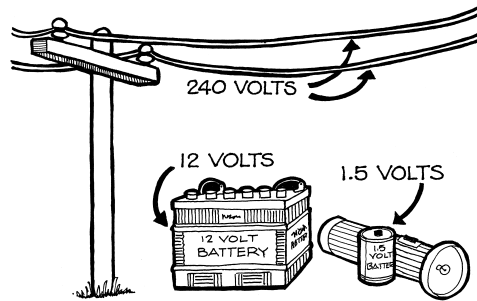

Electrical pressure is measured in volts.

The amount of electrical pressure (voltage) needed increases with the amount of power needed and the distance from the source to the load.

A 1.5 V battery for a torch has a low voltage and can only provide a small amount of power close by.

A 12 V battery can provide moderate amounts of power close by.

With 240 V, larger amounts of power can be delivered over longer distances.

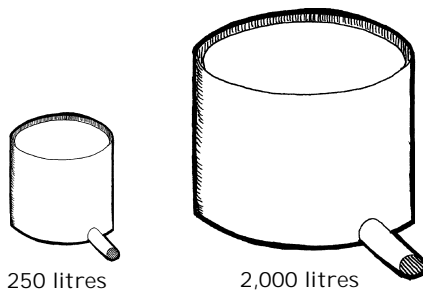

Water volume is determined by the size of the tank. It is measured in litres.

a rainwater storage tank standing on the ground. Low pressures are all right when the water is being used very close to the storage tank. A pressure of 10 kg/cm<sup>2</sup> is high and might be found at the outlet of a pump driven by a diesel engine, or the outlet of a tank on a high tower. It takes a lot of force to move water through long pipes, so high pressures are needed when water must be moved long distances.

Electrical pressure is the force that pushes electricity through a wire. The measure of electrical pressure is the same everywhere. It is measured in volts (V). A low electrical pressure of 1½ V is the pressure provided by one dry cell as used in an electric torch or radio. A medium electrical pressure of 120 V to 240 V is found at electrical power points in city homes. High voltages of more than 1,000 V are needed to move electricity long distances or for providing very high power. Most home PV systems operate at 12 V.

## VOLUME

The amount of water in a tank is its volume. Many different measures of water volume are used. The litre (l) is the measure of volume used in most countries. Another common measure of volume is the gallon. A household rainwater tank may hold 4,000 litres. Another measure of volume is the cubic metre (m<sup>3</sup>). 1 m<sup>3</sup> is the same volume as 1,000 litres.

There are also several measures of electrical volume, such as the coulomb (C). A torch cell may hold an electrical volume of 1,500 C. A solar battery may hold an electrical volume of 360,000 C. Another more common measure of electrical volume is the ampere-hour (Ah). An electrical volume of 1 Ah is the same as an electrical volume of 3,600 C, so a battery holding 360,000 C is the same size as a battery that holds 100 Ah.

## FLOW RATE

When water moves through a pipe, it is said to flow. The *volume* of water (gallons, litres or cubic metres) that flows through a pipe in one unit of *time* (1 second, 1 minute or 1 hour) is called the flow rate. It is often measured in litres per minute or gallons per hour. A pipe from a rainwater tank may have a flow rate of 10 litres/minute when a tap is turned on, while a pump driven by a diesel engine may give a water flow rate of 1,000 litres/minute.

When electricity moves through a wire, it is sometimes said to flow like water but it is usually said to have a current rather than a flow rate. So electricity moving through a wire is called an electric current and is measured in amperes (A). 1 A is a volume of 1 C flowing through a wire over a time of 1 second. So an ampere is a one-coulomb-per-second flow rate. 1 A is also the average current when 1 Ah of electrical volume flows through a wire over a period of 1 hour. The current that flows through a solar-powered light may be less than 1 A, while that needed to run a large solar-powered video may be 30 A.

## RESISTANCE

Electricity flows through wires like water flows through pipes. Pipes allow water to be carried from one place to another just as wires allow electricity to be carried from place to place.

With water, the longer the pipe the lower the flow of water that a particular pressure can push through the pipe. For a given pressure, a very long pipe will have a much lower flow of water than a short one of the same size. This is because the longer

360,000 coulombs or  
100 ampere-hours

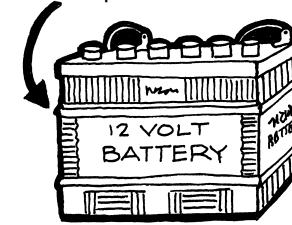

1,500 coulombs or  
42 ampere-hours

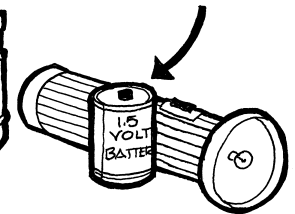

Electrical volume is determined by the size and type of battery. It is measured in coulombs or ampere-hours.

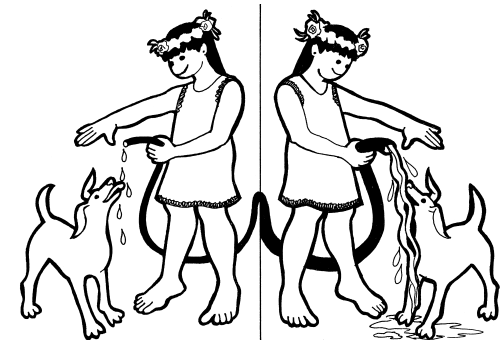

The smaller the pipe, the greater the resistance to water flow.



The smaller the wire, the greater the resistance to electricity flow.

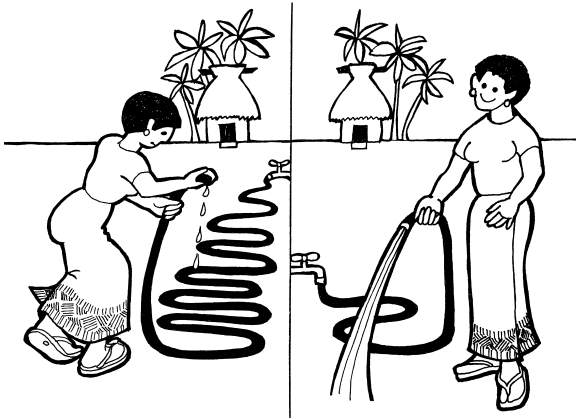

Resistance to the flow of water increases as the length of the liquid flow path increases.

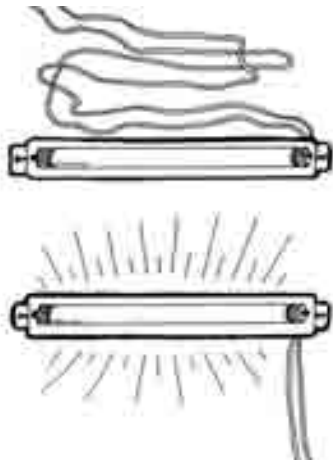

Resistance to the flow of electricity increases as the length of the electricity flow path increases.

the pipe, the more difficult it is to push water through the pipe. It is as if a very long pipe pushes back with a force against the flow of water. This force that opposes the flow of water is called flow resistance or just resistance. The resistance to water flow in a pipe increases in step with the length of the pipe, so a pipe twice as long resists flow twice as much. We say that it has a resistance of twice as much.

It is also harder to push water through a small pipe than a large one. The resistance increases in step with the decrease in the amount of space for the water to flow. The space for flow in a pipe is also called cross-sectional area or cross-section. It is usually measured in square centimetres ( $\text{cm}^2$ ) or square inches ( $\text{in}^2$ ). If a pipe has a cross-section of  $5 \text{ cm}^2$ , it will have twice the resistance to water flow as a pipe of the same length that is  $10 \text{ cm}^2$  in cross-section.

Make sure that you understand the difference between the diameter of a pipe and the cross-sectional area of a pipe. The diameter is the distance across the end of the pipe. The cross-sectional area is the total space available across the end of the pipe for water to flow. It is important to realize that if you double the diameter of a pipe, the cross-sectional area of that pipe is four times larger, not two times larger. The reason is that when you increase the diameter of the pipe in one direction, the diameter is also increased in the other direction because the pipe is round. If you double the diameter of the pipe in only one direction and therefore double the cross-section, the pipe would not be round, it would be a flattened oval. This means that if you change 100 m of 20 mm diameter pipe for 40 mm diameter pipe, the resistance is four times smaller because the cross-section of the 40 mm diameter pipe is four times larger than the cross-section of the 20 mm pipe.

Electricity flowing through a wire acts in the same way as water flowing through a pipe. If the wire length is doubled, the resistance of the wire is also doubled and it is twice as hard to force electricity through the wire. If the wire size (cross-sectional area) is cut in half, the resistance is doubled and it is twice as hard to push electricity through the wire.

With water, if the pressure stays the same and the pipe length is doubled, the flow rate is cut in half. In other words, if you want to keep the same flow rate through a pipe whose length has doubled – which makes the flow resistance also double – you have to double the pressure.

Looking at this differently, if you find that you have to double the length of a pipe and cannot change the pressure that forces the water through the pipe, then the only way you can keep the same flow rate as before is to cut the resistance to flow in half. To do this, lay an identical pipe alongside the first one and join them together. This gives double the space for water to flow and cuts the resistance in half. Another way is to take out the old pipe and put in a single new pipe with double the cross-sectional area of the old one.

This relationship can be stated as follows:

**water pressure** equals **flow rate** times **flow resistance**.

Or, in another way:

**water flow rate** equals **pressure** divided by **flow resistance**.

Or, in a third way:

**water flow resistance** equals **pressure** divided by **flow rate**.

Therefore if you know any two of the three terms, resistance, pressure or flow rate, you can easily calculate the third.

Electricity acts in the same way. If wire length (resistance) is doubled and voltage (electrical pressure) kept the same, the amperes flowing (electrical flow rate) are cut in half. If voltage is kept the same and wire length doubled, you can only have the same current by cutting the wire resistance in half. This can be done by doubling up the wire with another of the same size, or by replacing the old wire with a wire that has twice the cross-sectional area.

There is no common term or unit for measurement of pipe resistance but the unit used in measuring electric resistance is the ohm ( $\Omega$ ).

### Example 1

A voltage of 12 V forces a current (flow of electricity) of 4 A through an unknown resistance. What is the resistance in ohms?

$$\begin{aligned} \text{Resistance} &= \text{volts} \div \text{amperes} \\ &= 12 \div 4 \\ &= 3 \Omega \end{aligned}$$

### Example 2

A resistance of 6  $\Omega$  is placed across a voltage of 24 V. What current flows?

$$\begin{aligned} \text{Current} &= \text{volts} \div \text{ohms} \\ &= 24 \div 6 \\ &= 4 \text{ A} \end{aligned}$$

### Example 3

A resistance of 3  $\Omega$  is measured to have a current of 2 A flowing through it. What voltage is there across the resistance?

$$\begin{aligned} \text{Volts} &= \text{amperes} \times \text{ohms} \\ &= 2 \times 3 \\ &= 6 \text{ V} \end{aligned}$$

The relationship between volts, amperes and ohms is usually stated as a formula:

$$E = IR$$

where E stands for volts (from the French term for electrical pressure: 'electromotive force'), I stands for amperes (from the French term for electrical flow rate: 'electrical intensity') and R stands for ohms (resistance). The same formula can be rearranged so if any two of the three terms are known, the third can be calculated. To help remember the formulas, a circle diagram is used to represent the three ways to state the formula:

$$E = IR, I = E/R, R = E/I.$$

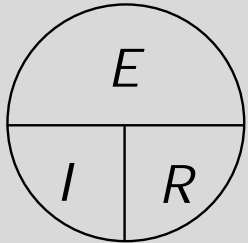

The interaction between electrical pressure in volts, electrical flow rate in amperes and flow resistance in ohms is:

**volts equals amperes times ohms.**

This is the electrical equivalent of:

**water pressure equals flow rate times flow resistance.**

Or, put another way:

**amperes equals voltage divided by ohms.**

This is the electrical equivalent of:

**water flow rate equals pressure divided by flow resistance.**

Or, in a third way:

**ohms equals voltage divided by amperes.**

This is the electrical equivalent of:

**water flow resistance equals pressure divided by flow rate.**

Therefore if you know any two of the three units, amperes, volts or ohms, you can always calculate the third.

## POWER

---

Power is the ability to do work. A powerful machine can do a lot of work. Anyone living near the ocean knows the power of moving water. If you have ever had to swim against an outflowing tide, you know that there is power even in slowly moving water. If the water volume is high and the flow rapid, as with high breakers along the reef or a fast-flowing river, the power is great and can injure or even kill you.

If you place your hand in flowing water, you can feel the force pushing against your hand. The flow of water is producing a small amount of power. If the water is under

high pressure or a large volume of water is flowing, the pressure on your hand is greater and we say that there is more power. So the power increases if either the water pressure or the water flow rate increases.

Think about the water flow from the tap on a rainwater tank. If it is barely turned on and there is little flow, the force on your hand under the tap is low. If you open the tap all the way, the power is greater. The power increases in step with the flow rate. If the flow rate doubles, the power doubles.

Also, if the tank is nearly empty and the pressure very low, the force on your hand is also low. If the tank is full and the water pressure high, the force is also high. The power provided by the flow of water increases in step with the pressure. If the pressure doubles, the power doubles.

So the power from a stream of water increases both with increased flow rate and increased pressure. If both the pressure and the flow rate double, the total power is raised four times; twice from the doubling of flow rate and twice again from the doubling of pressure. So power equals flow rate times pressure.

Electrical power works in the same way. If the pressure (volts) doubles and the flow rate (current in amperes) stays the same, the power doubles. If the current triples and the voltage stays the same, the power triples. If the voltage doubles and the current triples, the power increases six times. Electrical power equals flow rate in amperes times pressure in volts.

The measure used for electrical power is the watt (W). 1 W is the power produced by a current of 1 A driven by an electrical pressure of 1 V. If the electrical pressure of a PV system is 12 V and it operates a light that uses 2 A, the power used is  $12 \text{ V} \times 2 \text{ A} = 24 \text{ W}$ .

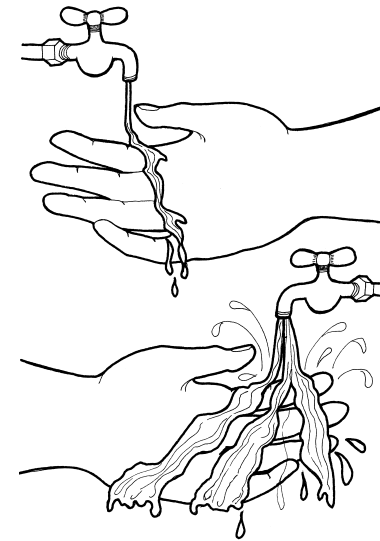

Power depends on the flow rate.

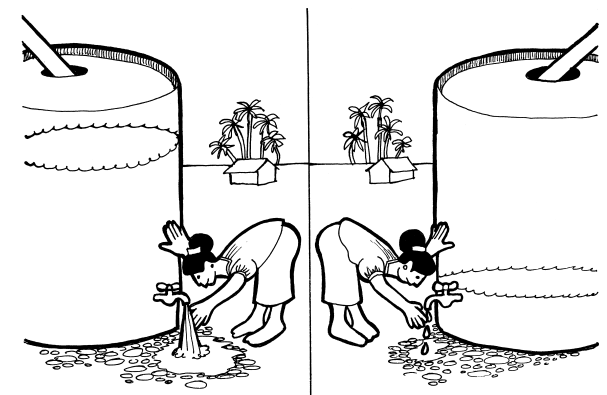

Power depends on the pressure.

If the flow rate doubles and the pressure triples, what happens to the power?

$$2 \times 3 = 6$$

The power goes up six times.

If the flow rate doubles and the pressure is cut by half, what happens to the power?

$$2 \times \frac{1}{2} = 1$$

The power is the same.

### Example 1

A video uses 30 A at 12 V. Its power requirement in watts is:

$$30 \text{ A} \times 12 \text{ V} = 360 \text{ W}$$

### Example 2

A pump uses 10 A at 48 V. Its power requirement in watts is:

$$10 \text{ A} \times 48 \text{ V} = 480 \text{ W}$$

### Example 3

A light uses 1.5 A at 12 V. Its power requirement is:

$$1.5 \text{ A} \times 12 \text{ V} = 18 \text{ W}$$

### Example 4

If a refrigerator using 120 W requires a current of 10 A, what voltage is present?

$$?? \text{ V} \times 10 \text{ A} = 120 \text{ W}$$

$$120 \text{ W} \div 10 \text{ A} = 12 \text{ V}$$

Remember that electrical power in watts is voltage times amperage, just as water power is pressure times flow rate.

If a 24 W light is connected to a 12 V source of electricity, how much current will flow?

$$12 \text{ V} \times ?? \text{ A} = 24 \text{ W}$$

$$24 \div 12 = 2 \text{ A}$$

So if you know the power in watts you can find the current in amperes if you divide watts by volts. If you know the wattage, you can find the voltage if you divide watts by amperes.

## ENERGY

---

The terms power and energy are often confused. Power is the *ability* to do work. Energy is the total *actual* work that is done. A large, strong man may have great power but if he is lazy and sleeps all day, he does little work and produces little energy.

To see the difference between power and energy, think of an outboard motor. The power of an outboard motor is measured in horsepower. A 40 horsepower outboard has twice the power of a 20 horsepower model. You might think that the 40 horsepower motor provides twice the energy of the 20 horsepower unit but that is not necessarily true. Remember that energy is a measure of actual work done. Even though something is powerful, little work may be done because the power is used for only a short time.

A strong man who sleeps most of the day does much less work than a weak man who labours all day. A 40 horsepower motor operated for a few minutes moves a boat only a short distance while a 20 horsepower motor operated all day will move the same boat a long distance. But the 40 horsepower motor will move a boat much further than a 20 horsepower motor during the same time. The energy produced depends both on the power available and on the length of time the power is applied. Multiplying the power by the time the power is used gives the amount of energy. As the electrical measure of power is the watt, in electrical terms energy is measured as watts times hours or watt-hours (Wh).

An electrical appliance that delivers a power of 5 W for 2 hours provides  $5 \times 2 = 10$  Wh of energy. If a light requires 20 W to operate and is run for 4 hours, the energy used is  $20 \times 4 = 80$  Wh.

Because it is *energy* that the solar panels provide to the battery and *energy* that goes to the appliances from the battery, it is the flow of *energy*, not the power, that determines how large the panels and batteries must be. An appliance, such as a small light, that uses little energy in an hour can operate many hours from a charged battery. An appliance that uses a lot of energy in an hour, such as a large colour television, will operate only a short time from the same charged battery.

## CIRCUITS

A piping system for rainwater may be simply a short pipe with a tap at the end or it may have many branches going to different places. The pipe and its connections are called a water circuit. For water to flow all the way from the tank to the appliance



The amount of energy used depends on both the power and the amount of time it is used. This outboard motor is out of energy (fuel) because the engine was run for too long.

Starting with a battery that holds 1,200 watt-hours of electricity:

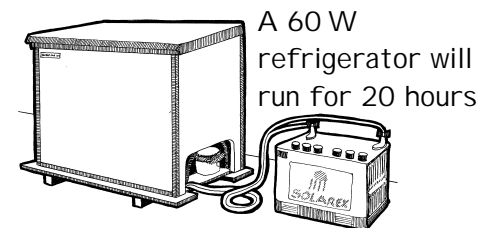

A 60 W refrigerator will run for 20 hours

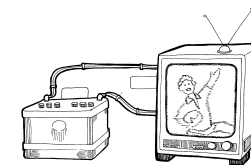

A 25 watt TV will run for 48 hours

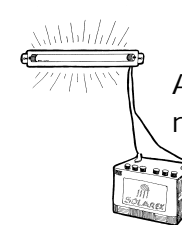

And a 12 W light will run for 100 hours

With a particular battery, the amount of time an appliance will run depends on its power needs.



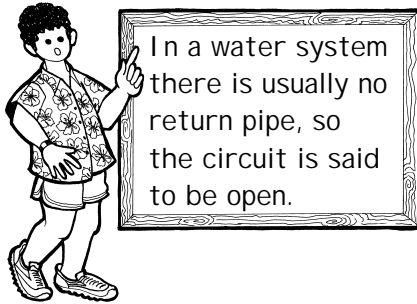

there must be a continuous pipe connecting them. If the pipe is disconnected or broken, the water will not flow to the appliance and it will not work.

A drawing of a water circuit, showing the water source, the pipe paths and connections and the appliances, is called a plumbing circuit diagram. On the diagram you can trace the flow of water from source to appliance.

Like water circuits, electrical circuits for PV systems can be very simple with a battery joined to a light. A circuit can also be complex with several batteries and many appliances all joined together. When electrical elements, such as batteries, resistances, motors and appliances, are connected with wires, an electrical circuit is created.

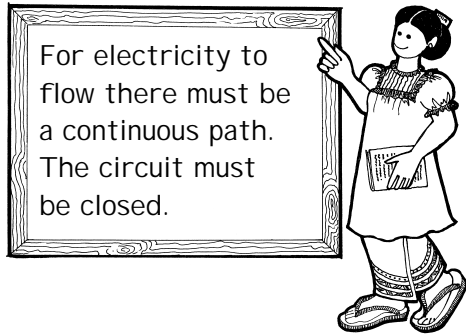

There is one big difference between the way a water circuit and an electrical circuit work. A water circuit usually ends with the appliance and the water flowing away into a drain. In an electrical circuit, the electricity cannot flow outside a wire, so there must be a wire to carry electricity away from the appliance as well as a wire to carry electricity to the appliance. This *return* wire goes back to the power source, where the returned electricity is pumped back up to full voltage and sent back to the appliance. In an electrical circuit, the electricity must have a continuous path not only to the appliance but also from the appliance back to the source. If the path is broken at any point, the flow of electricity stops. If a continuous path does not exist, then we say that the circuit is *open*. If a continuous path is present, then the circuit is *closed*. Electricity will flow through a closed circuit but will not flow through an open circuit. A switch is an electrical device that allows you to open or close a circuit to turn the electricity flow off or on.

It is important to know the polarity and observe it when connecting wires in a PV electrical system.

Connecting the wrong poles can cause damage, a fire or even an explosion.

## ■ Polarity

It makes a difference to most PV-powered appliances which way the electricity flows. If you reverse the connections of a flush toilet it will not work, and if you reverse the connections of a solar light it probably will not work either. With a water appliance, the inlet pipe is usually clearly marked. The same is true of connections in a PV system. The markings are usually + and - or spelled out as positive and negative. The + side is called the positive pole and the - side the negative pole. The arrangement of + and - is called the polarity of the unit. Polarity is simply a way of showing the direction of the electrical flow. Appliances usually have their + pole connected to the + pole of the battery and their - pole to the - pole of the battery.

## ■ Series circuits

When electrical elements are connected end to end, they are said to be connected in series. To connect two wires in series, one end of the first wire is connected to one end of the second wire, creating a single wire as long as the two together. This is like connecting two short pipes to make one longer pipe. Note that the resistance of the resulting long wire (or pipe) is the sum of the resistances of the individual wires (or pipes).

If a long pipe is made by connecting shorter pipes end to end, any water that goes into one end must pass through all the pipe sections to reach the other end. The same flow rate is present everywhere in the circuit. All the electricity that goes into one end of electrical components connected in series will pass through each component to reach the other end and the same amperes will flow everywhere in the wire.

If water tanks are stacked one over the other, the pressure from the bottom tank will increase. In PV systems, batteries and panels are often connected in series to increase the available voltage. If two 12 V batteries that can each produce 10 A are connected in series, 24 V is produced at 10 A. If three 18 V panels each producing 3 A are connected in series,

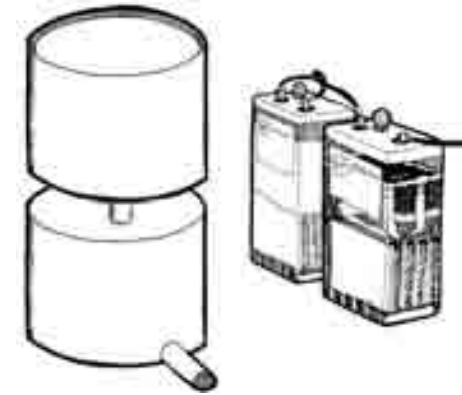

Stacking two tanks in series will double the pressure but keep the flow rate the same.

Two batteries connected in series doubles the voltage while the amperes available remain the same.

All components in a series circuit have the same electric current (amperes) flowing through them.

The voltage found across each component will vary according to the electrical characteristics of that component.

All components connected in parallel have the same voltage across their terminals.

The electric current (amperes) that flows through each of the components will vary according to the electrical characteristics of the components.

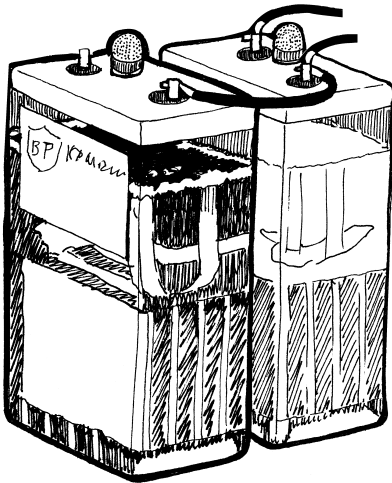
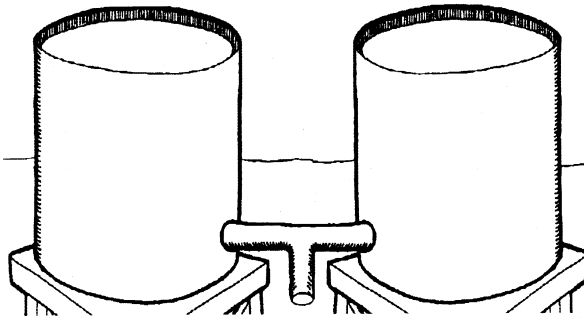

Two tanks connected in parallel deliver twice the flow at the same pressure.

Two batteries wired in parallel deliver twice the amperes at the same voltage.

54V at 3 A is produced. The voltage from batteries or panels connected in series is the sum of the individual voltages. The amount of amperes produced is the same as from one battery or panel.

### ■ Parallel circuits

When electrical components are connected side by side, they are said to be connected in parallel. To connect two wires in parallel, one end of each wire is joined together then the other ends of each wire are joined together. The result is two wires side by side with their ends connected.

This is like laying two small pipes side by side then joining them at both ends. When the water is turned on, part of it flows through one pipe and part through the other. The flow is split. If one pipe is large and the other is small, more water will flow through the large pipe than the small one. This is because the same pressure is present in both pipes but their resistances are different. The same thing happens in a parallel electrical circuit: the electrical flow is split among each of the branches according to the flow resistance of each branch.

If several water tanks are set side by side and interconnected, the pressure will be the same as from one tank but the flow of water will be increased. In PV systems, batteries and panels are sometimes connected in parallel to increase the available current. If two 12 V batteries that can each produce 10 A are connected in parallel, 12 V is produced with a possible 20 A of current. If three 18 V panels each producing 3 A are connected in parallel, 18 V at 9 A is produced. The voltage from batteries or panels connected in parallel is the same as that produced by one unit. The amount of amperes produced is the sum of the individual currents.

## ALTERNATING CURRENT (AC)

The electricity that we have discussed so far can be thought of as flowing directly from a source (such as a battery) through wires to the point of use (such as a light). This type of electrical power is called direct current (dc). Solar panels and batteries produce dc electricity.

The electrical power provided by engine-driven rotating generators, from the smallest portable generator up to the largest city power plant, is usually not direct current. This type of electrical power flows in one direction for a short time then reverses to flow in the other direction an equally short time before reversing again. It is called alternating current (ac) because the electricity constantly alternates its direction of flow. The forward and backward repetition of direction is called a cycle and the number of cycles that occur in 1 second is called the ac frequency. Frequency is measured in hertz (Hz). Power-plant frequencies are either 50 Hz or 60 Hz, depending on the power standards of the country.

Alternating current power can be converted to direct current using a *rectifier*. Direct current can be converted to alternating current using an *inverter*. These conversions cannot be made without the loss of some power and, unless care is taken, the power produced may be of poor quality.

Unlike dc, ac has no polarity. This is because polarity indicates the direction of electrical flow and in an ac system the flow reverses many times a second.

Which is better, ac or dc power? Both have advantages and disadvantages. Large power systems commonly use ac, while dc power is more efficient to transport and use but more difficult to produce in large quantities, and operating voltages are difficult

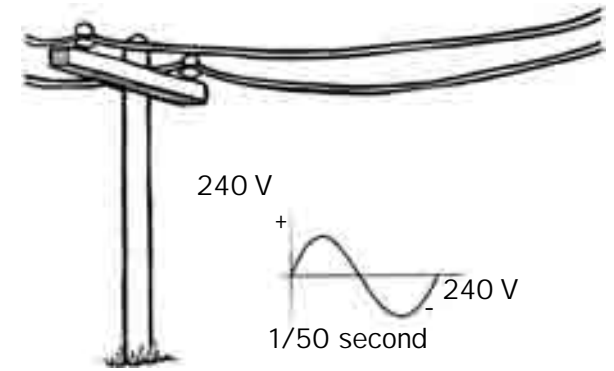

Electricity from city generators is alternating current (ac). The voltage changes constantly and the polarity reverses many times a second.

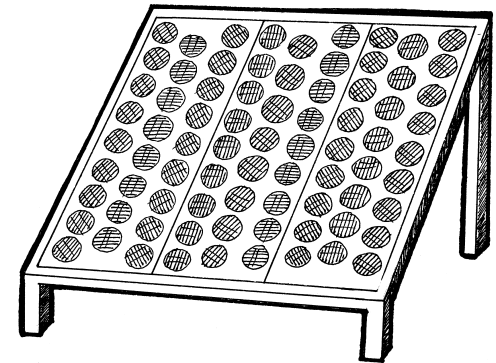

Electricity from solar photovoltaic panels is direct current (dc). It does not change voltage or polarity.

to change. The decision whether to use ac or dc is usually based on what technology is to be used to create the power. Home appliances designed to operate on dc do exactly the same job as those designed to work on ac and both are widely available, though ac appliances are more common. As solar panels produce dc, that is the usual choice for solar PV systems. In a few cases where dc appliances are hard to find, an inverter to convert solar-generated dc to ac may be used. Such conversions should be avoided where possible because of the added cost of the inverter and its use of additional electrical energy for its own operation.

## CONCLUSION

---

Electricity flowing through wires acts in many of the same ways as water flowing through pipes. Whenever you are confused or have a problem understanding electricity, think about how a similar water system would work. Remember that electrical pressure is measured in volts, electrical flow rate in amperes and electrical resistance to flow in ohms. The units of power and energy are watts and watt-hours and those same units are used both for water power and water energy and electrical power and electrical energy.

# 3 Photovoltaic panels

## INTRODUCTION

---

In a PV system, the part that converts sunlight to electricity is called a photovoltaic panel (PV panel). It is expensive and very difficult to make, but simple to use. All you have to do to make electricity is to place it in the sun.

## PANEL CONSTRUCTION

---

Most solar panels normally used for power production in rural areas are made up of a number of individual cells. The cells may be round, square or some other shape.

Each cell produces about  $\frac{1}{2}$  volt, no matter what its size. The amount of amperes a cell can produce does depend on its size, with larger cells producing more amperes.

As each cell only produces about  $\frac{1}{2}$  volt, many cells have to be connected in series to produce a high enough voltage to charge a 12 V battery. Usually there are from 30 to 36 of these cells on a panel that is intended to charge a 12 V battery, to make sure that the maximum voltage from the panel is high enough.

### AMORPHOUS PANELS

You may see solar panels that do not have individual cells. These are a newer type called amorphous silicon or thin-film panels. Their use is increasing, particularly for small PV systems. There is still uncertainty about how long they last. For remote rural locations where very long life and high reliability is needed, panels with individual cells are by far the most popular.

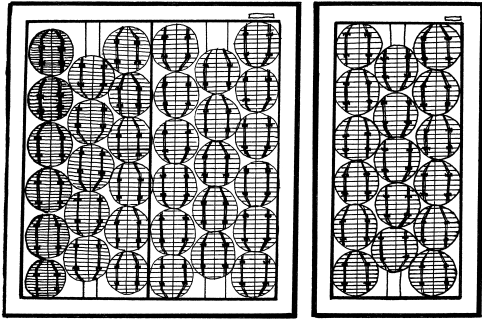

Panels are made up of many individual cells connected in series. The big panel has 36 cells and is for 12 V systems.

The small 9-cell panel is for 6 V systems. The larger the panel, the greater the electrical energy produced.



For best results, there should be no shade on a solar panel between 09:00 and 15:00. Even if only one cell is shaded, the output can be cut by half or even more.

Because panels with less than 36 cells do not charge a 12 V lighting system battery quickly enough in the tropics, no panels should be used that do not have at least 36 cells, and panels with 36 to 48 cells are better.

Panels with more than 48 cells will also work well. Unfortunately, they cost more and do not provide any advantage over 48-cell units for battery charging. The extra cost for panels that have more than 48 cells is not justified for charging a 12 V battery.

## WHAT AFFECTS ELECTRICITY OUTPUT

### ■ Effect of panel area

Just as a large roof collects more water than a small one, the larger the solar panel, the more electricity is produced. If you double the amount of surface covered by panels, the electricity output is doubled.

### ■ Effect of sun's brightness

The harder it rains, the more water you obtain from a roof. PV panels work the same way with the sun. The more sunlight that falls on the panel, the more electricity is produced. If there is shade on a panel, the electricity output falls greatly.

### ■ Effect of panel direction

If you stand in a rainstorm with a strong wind blowing, the side of you facing the wind gets much wetter than the side away from the wind. To get the most electricity from a solar panel, it must be facing the sun.

## ■ Effect of heat

You work better if you are not too hot. Solar panels also work best when kept cool. The hotter the panel, the less power it provides.

## GETTING THE MOST ELECTRICITY FROM A PANEL

Because PV panels are expensive, try to get as much electricity from them as you can.

### ■ Make sure that the brightest sunlight falls on the panel

The brightest sun is where there is no shade. Solar panels lose most of their electricity output when even a small part of the panel is in the shade. It is very important that solar panels are placed where the sun will shine on them from at least 09:00 to 15:00 without any shade at all.

Always remember that the sun shifts its position from north to south over the year as well as from east to west during the day.

In the tropics, the sun will be more in the northern sky for the months around June and more in the southern sky for the months around December. So you must pay attention to trees and buildings both to the north and south of the panel and make sure they will not cause shade at any time of year.

### ■ Make sure that the panel faces the sun

Most electricity will come from the panel when it points directly towards the sun. But because the sun moves across the sky from morning to night, the panel would have to move to always

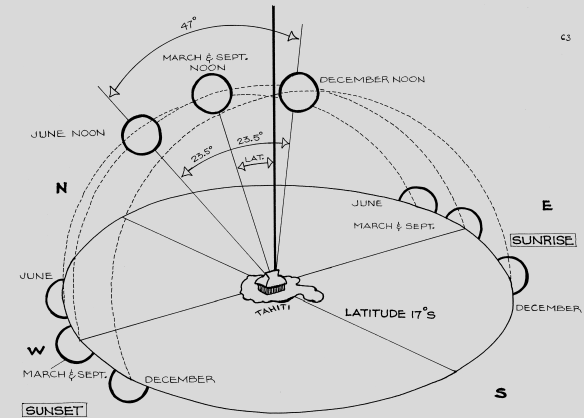

The sun not only moves from east to west during the day, it moves north and south with the seasons. The sun is furthest north in June when it rises to the north of due east and sets to the north of due west.

In December it is furthest south and the sun rises to the south of east and sets to the south of west.

On 21 March and 21 September the sun rises exactly in the east and sets exactly in the west.

The sun is always at its highest at noon. Its height at noon depends on the time of year and how far the site is from the equator.

When installing solar panels in the tropics, remember that sometimes the sun is in the northern sky and sometimes it is in the southern sky. A location that may be in the sun all day in June may be shaded all day in December.



### THREE RULES TO GET THE BEST OUTPUT FROM SOLAR PANELS

#### Rule 1

There should be no shade on the panel between 09:00 and 15:00.

#### Rule 2

Tilt the panel at an angle equal to the latitude of the site, though it should never be tilted less than 5 degrees from horizontal. The panel should face north for sites south of the equator and it should face south for sites north of the equator.

#### Rule 3

Mount the panel at least 10 cm above other surfaces so air can easily cool the back of the panel.

face the sun. This is not practical in most places and the best we can do is to fix the panel facing in the direction where the sun is located when it is brightest. The sun is brightest at noon. The location of the sun at noon depends on the time of year and how far you are from the equator. The best mounting for a solar panel is with a tilt towards the equator equal to the latitude of the location. Thus a panel located at a site with a latitude of 12 degrees north of the equator should be mounted with a tilt of 12 degrees facing towards the south. A panel located at a site with a latitude of 18 degrees south of the equator would be best mounted with a tilt of 18 degrees towards the north. A panel mounted on the equator should have a tilt of 5 degrees towards any direction. A small tilt of 5 to 10 degrees is always needed to let rain wash off any dirt from the panel.

In the tropics when the latitude is less than 15 degrees, you do not have to be highly accurate in pointing the panel towards the equator. At latitudes higher than 15 degrees, the panel needs to be carefully pointed towards the equator to get the best power output.

### ■ Keep the panel as cool as possible

---

Because solar panels must be in the bright sun, it is difficult to stop them from getting hot. It helps if solar panels are mounted so that the wind can blow over both the top and bottom of the panels. That means they should not be mounted directly on a roof but at least 10 cm above the roof, so that air can move all around the panels and cool them.

## ARRAYS OF MORE THAN ONE PANEL

---

Most people want more power than a single solar PV panel can provide. To increase the power available, panels may be joined together. Panels can be connected in two ways: series connections or parallel connections.

### ■ Series-connected panels

When more voltage is needed than a single panel can provide, additional panels are connected in series. If one panel provides 12 V, two in series will provide 12 + 12 or 24 V. Three in series will provide 12 + 12 + 12 or 36 V. For every 12 V panel connected in series to other 12 V panels, the voltage will increase by another 12 V.

The amount of amperes provided by panels in series is the same as that provided by one panel because the same electricity flows through all the panels, as they are connected in one long line. Each panel increases the electrical pressure but the flow stays the same as with one panel. As power in watts equals volts times amperes, the power increases as panels are added.

### ■ Parallel-connected panels

When the voltage from a single panel is the amount needed but there is not enough current, panels can be connected in parallel. If one panel provides 2 A in bright sunlight, two in parallel will provide 2 + 2 or 4 A. For each of these 2 A panels connected in parallel, an extra 2 A will be produced in bright sunlight.

With parallel-connected panels, the voltage remains the same as with one panel but the amperage increases with each additional panel. As power in watts equals volts times amperes, the power increases as panels are added.

Note that for both series- and parallel-connected panels, the power increases as the number of panels is increased. Two panels in parallel produce the same power as two panels in series, but the voltage and amperage are different.

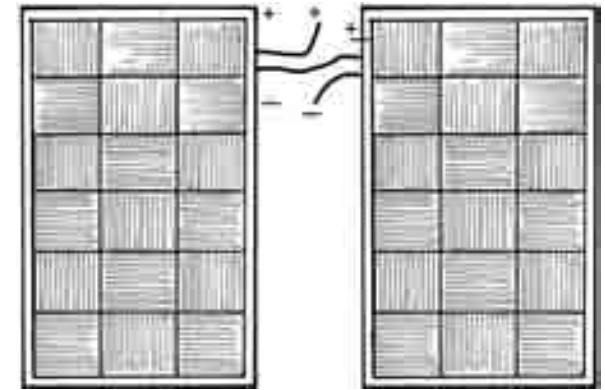

Two panels are connected in series by connecting the positive of one panel to the negative of the other. The result is doubled voltage but the same amperage as one panel.

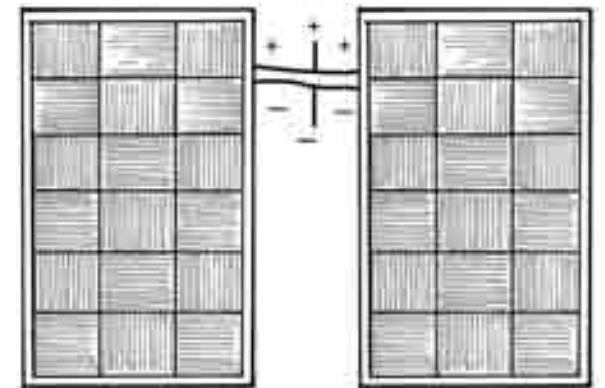

Two panels are connected in parallel by connecting terminals of the same polarity. The amperage is doubled but the voltage is the same as one panel.

### IMPORTANCE OF GOOD PANEL CONNECTIONS

All electricity from a photovoltaic system comes from the panels. If the connections to the panels are not clean, tight and properly made, some electricity will be lost and the system will not provide as much energy as it should.

Always be particularly careful in making connections at the solar panels. Use only screw terminals and make sure you use lock-washers on the screws so that they cannot loosen over time.

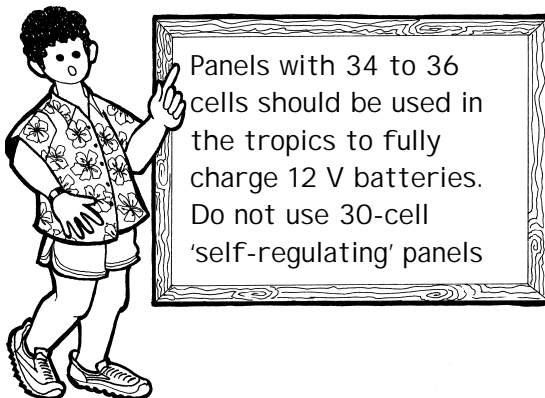

### ■ Series-parallel connections

Solar PV systems to power refrigerators and other large appliances often use a 24 V battery instead of a 12 V battery. Some even use 48 V batteries. As solar panels are almost always designed to charge 12 V batteries, two panels have to be connected in series to charge a 24 V battery and four panels have to be connected in series to charge a 48 V battery. Often more amperes are needed than one panel can provide, so panels have to be connected in parallel as well. This combination of series and parallel connections can be extended to as high a voltage as needed by adding more panels in series and as high an amperage as needed by adding more panels in parallel.

There are many different ways of connecting a large number of panels correctly to get the desired voltage and amperage. You can connect panels in series until the voltage is reached then connect more series-connected sets of panels in parallel until the amperage is reached.

You can also connect panels in parallel to get the amperes needed then connect more parallel-connected sets of panels in series to get the desired voltage. Perhaps this should be called a parallel-series connection, but it really does not matter because the final voltage and amperage are the same as in a series-parallel connection.

## CONNECTING PANELS WITH DIFFERENT CHARACTERISTICS

### ■ Series connections

If PV panels with different voltage and current (amperage) characteristics are connected in series, their voltages should be totalled just as when identical panels are connected in series. So if one panel that produces 16 V and another that produces 17 V under the same conditions are connected in series, the resulting voltage is  $16 + 17 = 33$  V.

However, the current available at maximum power will be limited by the panel with the lowest ampere capacity. Series-connecting a panel that by itself can produce 2 A with another that by itself can produce 3 A under the same conditions will result in a current of just over

2 A from the two panels. This means that to get the most out of series-connected panels that are not the same, the closer their ampere ratings match, the better the performance of the pair will be. As amperes are determined by the size of the cells, panels connected in series work best if the cells on both panels are the same size.

## ■ Parallel connections

If PV panels with different voltage and current characteristics are connected in parallel, their currents should be totalled just as when identical panels are connected in parallel. So if one panel produces 3 A and the other produces 2 A, the two in parallel will produce 5 A.

However, the voltage available at maximum power from the parallel-connected panels will be limited by the smaller of the two panel voltages. Parallel-connecting a panel that produces 16 V with one that produces 17 V under the same conditions results in a voltage a little greater than that of the 16 V panel. Thus, to get the most out of parallel-connected panels, they should have the same number of cells and produce about the same voltage.

## MOUNTING PANELS

Because solar panels are constantly exposed to wind and weather, it is important that their mounting is secure and resistant to corrosion or loosening.

Mounting panels on a roof is usually cheaper than mounting them on a pole. But if the roof is shaded or facing the wrong way, a pole must be used. Pole mounting provides better cooling for the panels than roof mounting. Pole-mounted panels usually have to be placed further from the battery than panels mounted on the roof, so will need larger wires to stop too much power loss through the wiring. The poles should be

### RULES FOR CONNECTING PANELS WITH DIFFERENT ELECTRICAL CHARACTERISTICS

#### Rule 1

When connecting different panels in series, the number of amperes (the rating) is important. The amperes from the series string will be limited to about the ampere rating of the panel with the lowest ampere output. For best results, ampere ratings should be matched for series connections.

As the ampere rating is fixed by the size of the individual cells (not their number), panels with cells of similar appearance will probably work well together.

#### Rule 2

When connecting different panels in parallel, the volt rating is important. As the volt rating is fixed by the number of cells (not their size), panels with the same number of cells will probably work well together.

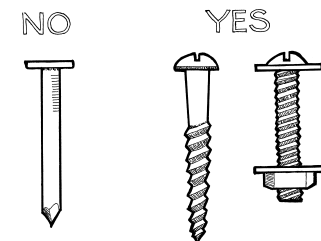

Nails loosen over time. Panels should never be mounted with anything but screws or bolts and they should be made from stainless steel or other material that will not rust.

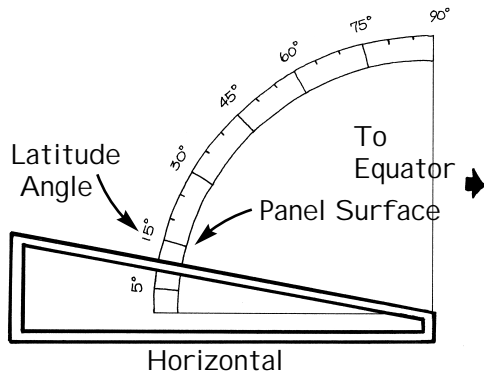

For most locations, most sunlight is received on a panel tilted towards the equator by an amount equal to the latitude of the site.

tall enough to prevent people from touching the bottom of the panels. Burying the wires is usually better than stringing them overhead, but make sure they are designed for underground use.

The panels should be attached with stainless-steel bolts or screws, not nails, which can loosen over time. If the panels are mounted on a pole, it should be set securely in the ground and anchored to a building if possible.

# 4 Controllers

## INTRODUCTION

In a water system, it is sometimes important that a storage tank should not become too full or too empty. A valve can be installed to turn off the water coming into the tank when the tank gets full. Another valve can be installed to prevent water from leaving the tank when the level falls too low. These two valves control the amount of water in the tank.

In a PV system, an electrical valve is usually installed to keep the battery from getting too full. This is called a charge controller. Another electrical valve is installed to keep the battery from completely running out of electricity. This is called a discharge controller. These valves control the amount of electricity in the battery.

## CHARGE CONTROLLER

Without a charge controller the panels can force too much electricity into the battery and overcharge it. When a battery is overcharged, it loses water rapidly, gets hot and may be damaged. A charge controller works like a valve on a rainwater collection system that prevents the water tank from overflowing.

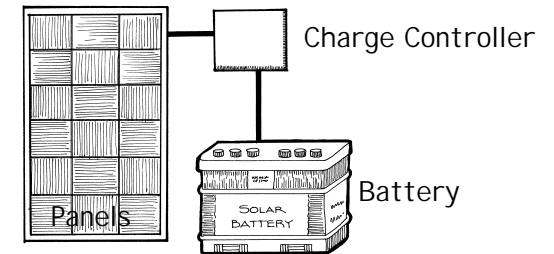

A charge controller is connected between the battery and the panels.

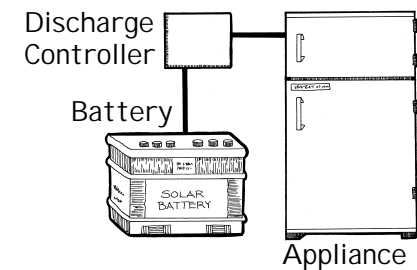

A discharge controller is connected between the battery and the appliances.

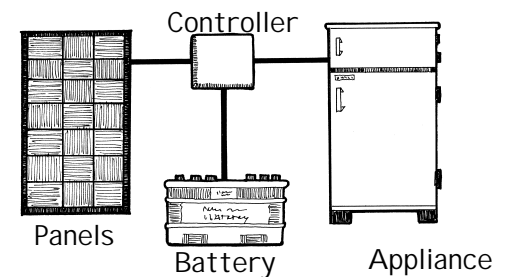

Charge and discharge controllers are often combined to make one controller.

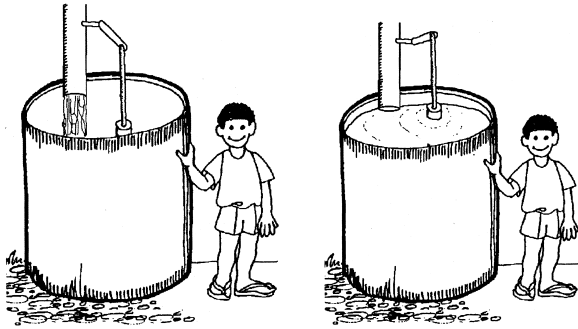

A series controller is like a valve that automatically shuts off the flow of water when a tank is full.

The charge controller must be connected between the panels and the battery. It works by constantly checking the voltage of the battery. If the voltage is so high that it shows that the battery is full, the controller automatically stops more electricity from going into the already full battery.

### ■ Series charge controller

There are two basic types of charge controller. One type is connected in series with the panels. It is a switch that shuts off electricity flow from the panels to the battery when full charge is reached. The switching may be done by a magnetic switch called a relay, but special switching transistors can also be used. A series controller is like a valve in a pipe leading to a tank that closes when the tank is full.

### ■ Parallel charge controller



A parallel controller is like an overflow pipe on a tank that stops it from getting too full.

The second type of charge controller is connected in parallel with the panels across their output wires. When it senses that the battery is fully charged, it shorts the panel wires and no more electricity can reach the battery. Although panels are not damaged by short circuits, batteries are damaged, so there must be a one-way valve between the controller and the battery to prevent the controller shorting the battery as well as the panels. This one-way valve is called a diode. Parallel controllers usually have a semiconductor (transistor) switch instead of a relay. In a water system, an overflow pipe that allows excess water to flow away when the tank is full works like a parallel controller.

## DISCHARGE CONTROLLER

The discharge controller stops appliances from taking too much electricity from the battery and discharging it too much. When a battery is too discharged, it loses some of

its capacity to be recharged, it is weakened and its life is shortened. A discharge control is like a valve on a rainwater collection system that stops you from taking all the water from the tank.

The discharge controller must be connected between the battery and the appliances. It works by continuously checking the voltage of the battery. If the voltage is so low that it shows that the battery is almost empty, the controller automatically disconnects the appliances so that no more electricity can be taken from the nearly empty battery. It is always connected in series with the battery.

## COMBINED CHARGE AND DISCHARGE CONTROLLERS

A charge controller and a discharge controller are often placed together in the same box. You can usually tell what kind of controller is present by looking to see what connections there are. If the controller box has connections that go to the panels, it usually means that it includes a charge controller. If the box has connections that go to the appliances, it usually means that it includes a discharge controller. All controllers are connected to the battery.

## INSTALLATION AND MAINTENANCE OF CONTROLLERS

Wire the controller into the circuit according to the instructions provided by the supplier of the controller. It is very important that you connect the correct wires to the correct terminals. The positive wire from the battery must be connected to the positive battery terminal on the controller. The positive terminal from the panels must be

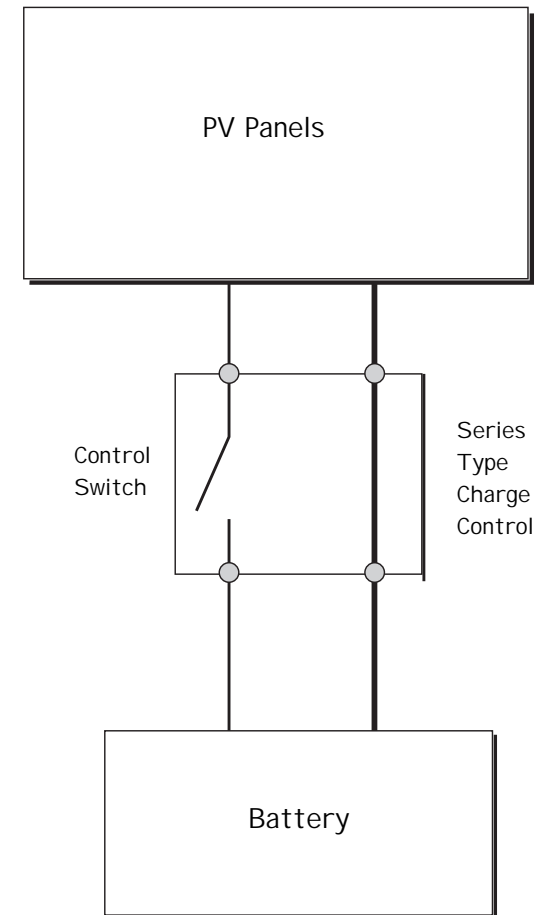

A series charge controller opens the circuit between panels and battery when the battery is full of electricity.



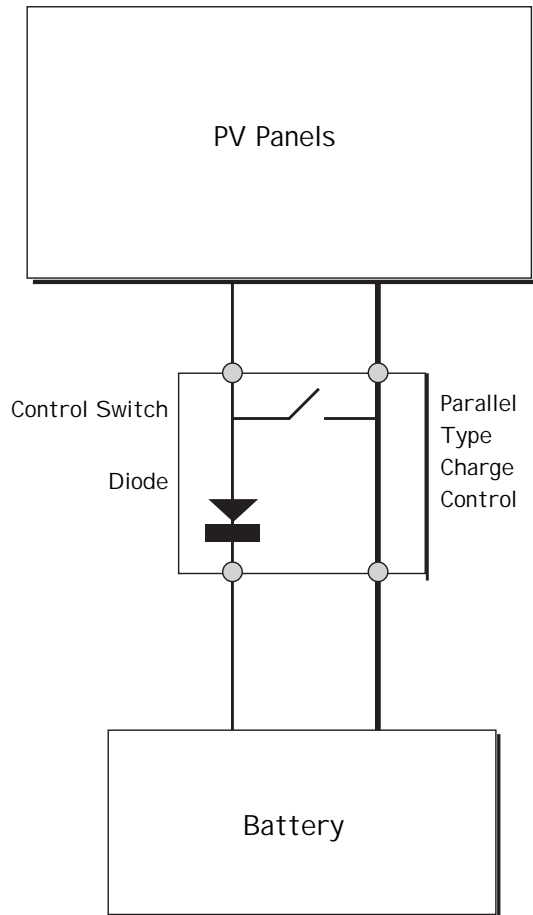

A parallel charge controller short circuits the panel when no more charge is needed in the battery. There is a diode between the battery and the control switch to prevent the battery from being shorted too.

connected to the positive panel terminal on the controller. If the controller is wired incorrectly it will not work and the controller and the battery may be damaged.

Some types of controller must have the battery connected before the panel. Other types must have the panel connected first. Always carefully follow the installation instructions.

The controller should be solidly mounted in a cool place out of the sun and rain and as close to the battery as is practical. The connections should be made according to the instructions and all connection screws tightened properly. If new appliances are added, make sure that the controller can handle the extra power without damage.

Long wires between the controller and the battery may cause problems because it is more difficult for the controller to measure the charge in the battery from a long distance. The wire between the controller and the battery should be no more than 2 m long and less than 1 m is best.

Semiconductor switches are easily damaged by lightning. Good-quality charge controllers with semiconductor switches include a circuit for dispersing the electricity generated by nearby lightning strikes so that it will not damage the controller.

Some controllers must have a wire that is properly earthed using a buried earthing rod, so that any electricity produced by lightning can go harmlessly into the ground instead of damaging the controller. The earthing device is usually a copper-clad steel rod driven a metre or more into the ground or a large, bare copper wire buried in a trench. Make sure that you carefully follow all installation instructions and, where required, install a proper earthing system. Some installations will require the PV panel

frame or mount to have an earth connection and others will not. Some types of installations will be safe from lightning with no earthing at all. Make sure that you carefully follow all instructions on earthing any part of the PV system. If you do not, the controller could easily be damaged by lightning.

Controllers can also be damaged by incorrect wiring, connection to appliances that require too much power, heat, insects, water and animals. But, when correctly installed, good-quality controllers rarely fail.

If a controller does not work well, always replace it with a good one and send the old one for repair. Never wire around the controller. Never change the controller adjustments. The adjustments tell the control circuits when the battery is full and when it is empty. Without special equipment and techniques, you cannot set them correctly. If you change the adjustments without the proper equipment and techniques, the system may seem to work but you will damage the battery and greatly shorten its life.

## CHARGE INDICATORS

---

Some controllers have lights or other indicators to show the user the condition of the battery and the operating mode of the system. These can be useful and if it is practical, you should mount the controller where the indicators can be easily seen. Do not, however, mount the controller more than 2 m from the battery just to see the indicators better.



Controllers may seem complicated. If you have a problem with a controller, remember that it is just like a valve in a water system. Think about how the water system works and it will help you to understand the PV system.

## SUMMARY

---

The charge and discharge controllers protect the expensive battery from damage from too much electricity being forced into it or from too much electricity being taken from it. If you need more electricity, it is much better to add another panel instead of wiring around the controller. If a controller fails and faulty connections are not the cause, replace it rather than trying to repair it.

# Batteries

## CHARACTERISTICS

The battery stores electricity produced by a solar panel for later use. It is an important part of solar PV systems that supply electricity at night or other times when the solar panel is not producing power.

The battery is one of the most expensive parts of a PV system. It also has the shortest life and is easily damaged by poor maintenance or incorrect use. The most important thing that a PV technician can learn is how to take care of batteries and how to tell if they are being damaged by people using a PV system incorrectly.

The type of battery most often used in a PV system is called a *lead-acid* battery. The name comes from the main materials in the battery, lead and sulphuric acid. The acid must be handled carefully because it can burn holes in your clothes, hurt your skin or damage your eyes.

Lead-acid batteries are made up of cells. Each cell produces about 2 V. A 12 V battery has six 2 V cells connected in series. A 24 V battery has twelve 2 V cells. The cells may all be contained in a single plastic case like a car battery, or they may be separate.

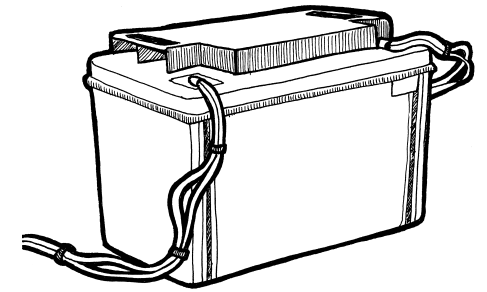

A lead-acid battery stores electricity for use when the sun is not shining. It is the part most easily damaged by incorrect use or poor maintenance.

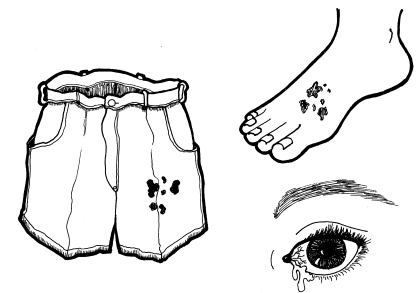

Lead-acid batteries contain sulphuric acid. This can damage clothes and skin. If acid gets in the eyes, it is very painful and can cause blindness.

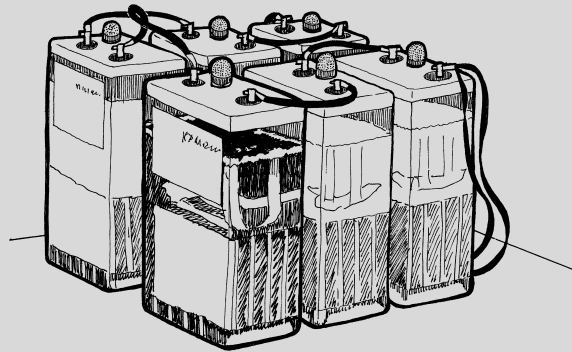
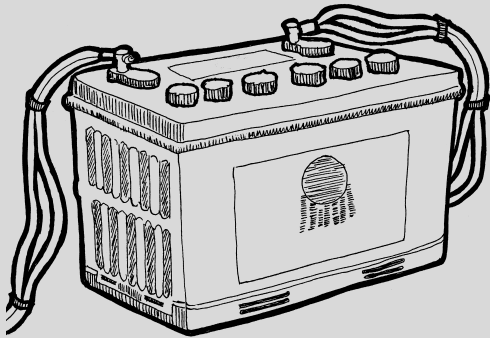

Both of the above lead-acid batteries are made up of six 2 V cells connected in series to make one 12 V battery.

The top battery has all six cells contained in one plastic case with the connections between cells inside the case. The bottom battery has separate 2 V cells and the six cells must be wired together by the installer to make 12 V.

Both batteries are open-cell types with removable cell caps.

Most batteries used for PV systems have removable caps on top so you can test the cells and add water when it is needed. They are called *open-cell* or *flooded-cell* batteries. Some batteries are sealed and cannot be maintained except at the factory. They are called *maintenance-free* or *sealed* batteries. This type of battery has a smooth top and no filler caps. If a sealed battery is provided for a PV system, there is nothing you can do to maintain it except to keep the connections clean and tight, keep the case clean, and make sure that people are using the system properly. Maintenance-free batteries are more expensive than open-cell batteries of the same capacity. Maintenance-free batteries do not last as long as open-cell batteries that are correctly maintained. It is best to use maintenance-free batteries only where there is no-one to maintain open-cell batteries.

Of all the parts of a PV system, the battery requires most care. It must be checked regularly to make sure that the liquid level is correct and only the purest water added if the cells are low.

## THE PV SYSTEM BATTERY IS SPECIAL

---

Although the solar battery may look like the battery used in cars, tractors and trucks, inside it is very different. Batteries used for vehicles are designed to provide large amounts of power for a short time, while solar batteries are designed to provide a small amount of power continuously for many hours.

A good long-distance runner is usually tall, thin and has long legs. A good sprinter usually has a compact and powerfully built body. If a long-distance runner is forced to sprint, he will not be very fast and may be injured. If a sprinter is entered for a long-distance race, he will be slow and may not even finish the race.

In the same way, if a PV system battery is used to try to start a tractor, car or truck, it will not work well and may be badly damaged. If a battery made for use in a car, truck or tractor is used in a PV system it will not last nearly as long as a battery made especially for PV systems. You should *never* allow a PV system battery to be used for any other purpose.

## REPLACING A BATTERY THAT HAS FAILED

Batteries are classified according to their type of construction and their ability to store electricity.

### ■ Type of battery

Several types of batteries are made. The type best suited for most PV systems is called a deep-discharge battery, because it is specially designed to deliver a high percentage of its power without any damage. You can regularly use 80% of the power stored in a deep-discharge battery without damage.

The most common battery type is the starting battery used for vehicles. It is designed to provide high power for a short time to start an engine. This type of battery is easily damaged by using a high percentage of the electricity stored in it. If you regularly use more than 20% to 30% of the power stored in a starting battery, it will not last long. Though a starting battery is cheaper than the same size of deep-discharge battery, it will not last as long when used in a PV system. If you have to replace it more frequently, using a starting battery may be more expensive in the end.

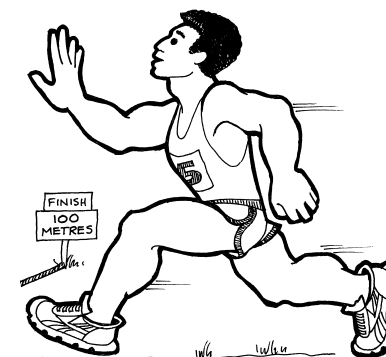

A car battery is like a sprinter. It produces a lot of energy for a short time.

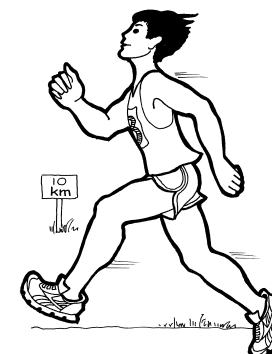

A solar battery is like a long-distance runner. It provides a moderate amount of energy continuously for a long time.

## REPLACING BATTERIES

When you replace a battery, try to find the same type and the same size of battery as originally installed.

If the original battery was a solar or deep-discharge type, you should not replace it with a vehicle or starting-type battery.

If the original battery was an open-cell type, you should not replace it with a 'maintenance-free' type of battery.

If you must replace a solar or deep-discharge battery with a starting battery, for longest life the new battery should have twice the capacity of the original battery. Thus if the original deep-discharge battery was 65 Ah, the new battery should have a capacity of at least 130 Ah.

If you must replace an open-cell battery with a maintenance-free battery, the new battery should have a capacity half as much again as the original battery. Thus if the original open-cell battery was 100 Ah, the new maintenance-free battery should be at least 150 Ah for longest life.

If you do not know the capacity of the original battery, or if the new battery does not have a capacity rating on it, you can compare the capacity of the two by comparing their weight. The heavier the battery, the more lead is inside and the more capacity it is likely to have.

## ■ Ability to store electricity

Batteries are classed according to how much electricity they can store. The measure used is the ampere-hour (Ah). If a battery delivers 1 A of current continuously for 100 hours it has provided 100 Ah. If a battery delivers 10 A continuously for 10 hours, it has also delivered 100 Ah. If 5 A is delivered continuously for 20 hours, that is 100 Ah too.

Ampere-hours are equal to the continuous current being taken from the battery times the number of hours it is delivered. If a current of 7 A is delivered for 6 hours, that will be  $6 \times 7 = 42$  Ah.

If a battery is rated at 100 Ah, it means that ideally it can be expected to deliver 1 A for 100 hours, or 10 A for 10 hours, 5 A for 20 hours or any combination of amperes and hours that equal 100 when multiplied together. In fact, it is not that simple because a battery can deliver more ampere-hours when it is discharged very slowly than when it is discharged quickly. Just as when you work very fast, you will get tired sooner and not do as much as if you work slowly and steadily. So if a battery can deliver 100 Ah when it is discharged quickly, it may be able to deliver 150 Ah when it is discharged slowly. Therefore to find the real ampere-hour capacity of a battery, you need to know how quickly it will be discharged. This is called the discharge rate. It is often stated as the number of hours for full discharge. So a battery may be rated as 50 Ah at a 10 hour discharge rate. Exactly the same battery may be rated as 70 Ah at a 100 hour discharge rate. Manufacturers show this on their specification sheets as  $C_{10}$  and  $C_{100}$  or as  $C/10$  and  $C/100$  rates.  $C_{10}$  means a battery capacity that will discharge completely from full charge in 10 hours.  $C_{100}$  means a battery capacity that will discharge completely from full charge in 100 hours. Be careful when comparing manufacturer's specifications for batteries.

When replacing a battery, the new one should never have a lower ampere-hour rating for the same discharge rate than the one originally installed. If the battery is a deep-discharge type, the replacement does not need to be higher in rating than the original battery. Some manufacturers of solar batteries advertise the capacity of their batteries as  $C_{100}$  and other manufacturers advertise  $C_{10}$  or  $C_{20}$ . Because a battery can deliver more ampere-hours if

discharged slowly, the  $C_{100}$  rating will make a battery look bigger. The same battery that is 100 Ah at  $C_{100}$  may be rated as only 65 Ah at  $C_{10}$ . Always compare batteries at the same discharge rate. Most people use a  $C_{10}$  rate as a standard for comparison. Here we always use a  $C_{10}$  rate for working out the size of a battery.

Starting-type (vehicle) batteries are not designed for PV systems but if a starting battery has to be used, obtain one at least twice as big as the solar-type battery originally installed. If the original battery with the PV system had a 105 Ah rating at  $C_{10}$  and you have to replace it with a vehicle battery, the replacement should have a rated capacity of at least 210 Ah. Even with the larger battery, it will not last as long as a proper deep-discharge type, but at least it should last for several years.

If an open-cell solar battery is to be replaced with a maintenance-free solar battery, the new battery should be half as large again as the old open-cell battery in order to last a similar time. So if the original open-cell battery had a capacity of 100 Ah at  $C_{10}$ , a maintenance-free solar battery to replace it should have a capacity of at least 150 Ah at  $C_{10}$ .

## DIFFERENCE BETWEEN A BATTERY FULL OF ELECTRICITY (CHARGED) AND AN EMPTY ONE (DISCHARGED)

It is easy to check whether a water tank is full or empty. It is more difficult to tell if a battery is full or empty of electricity as we cannot see electricity. A tester is used to find out whether a battery is charged or not.

Two types of tester are used to check how much electricity a battery contains. The most common type, called a hydrometer, checks the acid in the battery for strength. The stronger the acid, the more electricity is stored in the battery.

A hydrometer is a glass tube with a special float in it. The battery acid is sucked up into the tube by squeezing a bulb on top. The float then rises towards the top of the

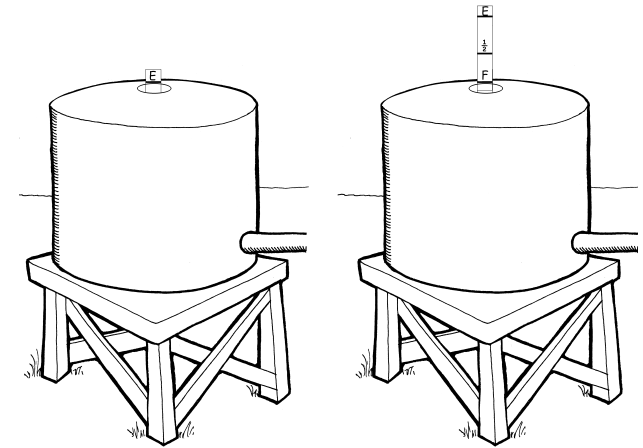

A float gauge in a water tank shows the amount of water in the tank by how high it floats.

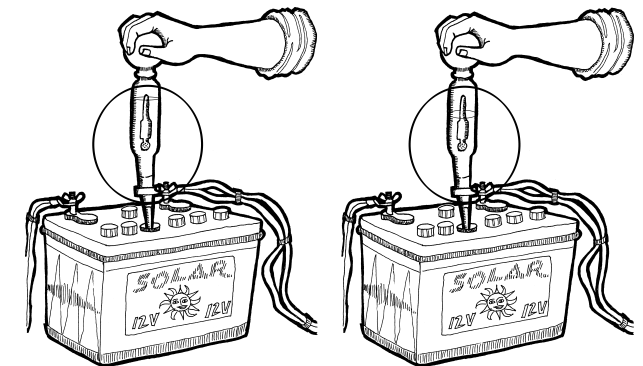

A hydrometer shows the level of charge in a battery by how high it floats.



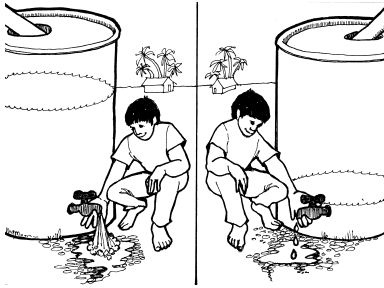

Water pressure is highest when the storage tank is full.

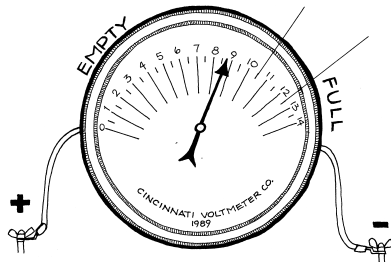

Electrical pressure (voltage) in a storage battery is highest when the battery is fully charged.

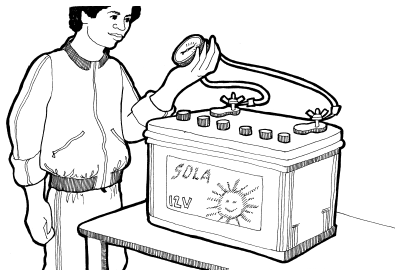

When a new battery is installed, let the solar system charge the battery for at least two sunny days before using any electricity.

liquid. Markings on the float show how strong the acid is. If the float rises high in the liquid, then the battery is full of electricity. If it floats low, the battery is low. If it rises part way, the battery is partly full. After testing, squeeze the bulb to return the liquid to the cell.

The hydrometer measurement is like a float gauge on a water tank. In a water tank, if the float is high, the water level is high. If it is low, the water level is also low.

In a battery, if the hydrometer float is high, the battery charge is high. If it floats low, the charge level is low.

Another way to check the amount of electricity in a battery is to use a voltmeter to measure the voltage (electrical pressure) of the battery. When a water tank is full, the pressure is higher at the outlet tap than when the tank is low on water. When a battery is full of electricity, the voltage is higher than when it is low on electricity.

A battery rated at 12 V will in fact measure over 13 V when it is fully charged and less than 11 V when the charge is getting low. A 12 V battery has very little charge left in it if its voltage falls below 11 V. In normal use, a deep-discharge battery should not be discharged to a voltage less than 11.5 V.

As the difference between the voltage of a low battery (11.5 V) and a full battery (13.5 V) is only 2 V, a high-quality voltmeter must be used to read the level of charge accurately.

Measuring the voltage level is the easiest way to check the charge in a battery but accurate voltmeters are expensive and easily damaged. A voltmeter also gives a different indication of battery charge than a hydrometer. For the most accurate checks it is better to use both a hydrometer and a voltmeter. If they both agree on the level of charge in the battery, the battery is probably all right. If the voltmeter shows a high level of charge and the hydrometer shows a low level of charge, then the battery may be damaged.

## INSTALLING A NEW BATTERY

The liquid (acid) used in storage batteries is called electrolyte. To install a new battery that already has electrolyte in it, first make sure that the level is correct in all the cells, then just connect the battery and allow it to charge from the solar panel for at least two sunny days before turning on any lights or other appliances. If a new battery is filled with electrolyte but the level in one or more of the cells is low, add only acid (*not* water) before connecting the battery to the PV system. In *all* cases, fully charge the battery before using it to operate any appliances.

If the new battery arrives with no liquid in the cells, the cells must be filled with electrolyte. Because the acid may harm eyes, skin and clothes it is important to handle it carefully.

Fill the battery slowly and be very careful not to spill any acid. You should fill each cell so slowly that you can count to at least thirty in the time it takes to fill it. It is best to put a little acid in one cell, then put some in another cell and rotate through all the cells before adding more to the first cell. This will make sure that you are not filling the cells too quickly.

Note that the battery becomes warm after it is filled. This is normal but it can get too hot and be damaged if it is filled too quickly, so always fill slowly and carefully.

If the battery comes with filling instructions, follow them carefully. If no instructions are provided, fill the cells so that the acid covers the plates in each cell but is below the bottom of the fill opening.

A newly filled battery should be immediately connected to the PV system and allowed to charge for at least two sunny days before any electricity is used. For the battery to last a long time, never connect appliances to the battery until after it has been fully charged by the solar panel.



**IMPORTANT:** If acid gets on your skin, eyes or clothes, wash it off immediately with lots of clean water.

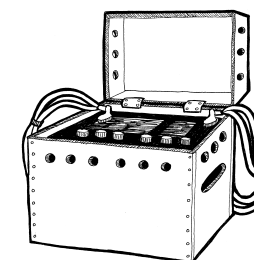

The battery should be installed in a plastic or wooden box with holes near the top to allow air to reach the battery and explosive gases to escape. Never use a metal box because the acid will corrode the metal.

The first step in maintaining a battery is to clean it with a wet cloth. Use only fresh water and do not use soap. Rinse the cloth after use because some acid may remain from cleaning the battery top.

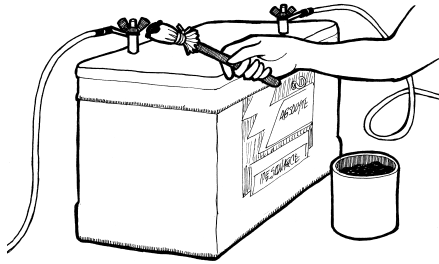

To prevent corrosion on the terminals and a high loss of charge through the battery connections, after assembly paint the surfaces of the battery terminals with heavy grease, petroleum jelly, or other material that keeps air and water off the terminals.

After a new battery is filled with acid, you should *never* add more acid unless the battery has been knocked over and the acid spilled out. As long as no acid has spilled out, add only pure, fresh water to the cells.

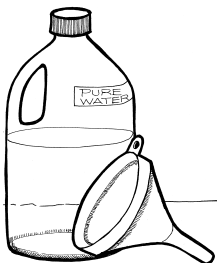

Always keep a good supply of pure, clean water for filling batteries. Use distilled water whenever possible.

The battery should be installed in a plastic or wooden box with holes through the sides near the top to allow air to reach the battery. Never use a metal box because the acid will corrode the metal. Plastic is best because wood will also be damaged by the acid, though less so than metal. If you use a wooden box, put a piece of plastic under the battery to protect the wood.

The battery should be installed on a hard, level surface. It should not be placed where small children can reach it because they may be hurt by the acid. Place the battery where it is not likely to be knocked over accidentally.

The wires should be firmly attached using bolts. Never use spring clips or just wrap the wire around the posts. After the connection is tightly made, paint the terminals with thick oil or grease to prevent corrosion. Do not paint the oil or grease anywhere except on the battery terminals and do not put oil or grease on the battery terminals before the connection is made.

## BATTERY MAINTENANCE

---

Three things must be done to maintain a PV system battery correctly.

### ■ Maintenance step 1

---

**Keep the battery clean.** If the top of the battery is dirty, corrosion will soon be a problem and electricity will begin to leak from the battery connections through the dirt. To clean the battery, use only fresh water and a rag. Do not use soap or salt water. Because a little acid will probably be on the battery, be careful not to touch your eyes with hands or rags that have touched the battery. Wash all rags and your hands in fresh water when you are finished. Paint the terminals with thick oil or grease again after cleaning.

## ■ Maintenance step 2

**Test each cell with the hydrometer.** All the cells should measure about the same when tested with the hydrometer. If one or more cells measure very differently from the others, the battery is probably beginning to fail. A failing battery can still be used as long as the system is working, but you should watch the battery very carefully to see if it gets worse.

You should keep a card near the battery and each time the battery is checked you should write down the hydrometer readings, voltage readings, and the date. Then you can compare the readings from earlier visits and you will usually be able to tell when a battery is gradually failing.

Sometimes there will not be enough electrolyte in a battery cell to suck up into the hydrometer to measure. In that case, add pure, clean, fresh water until the cell is filled to the correct level. Wait at least one day before taking a reading with the hydrometer after filling with water.

## ■ Maintenance step 3

**Keep the battery cells full of electrolyte.** The battery cells should be checked at least once a month and special, high-purity water added if the liquid is below the correct level. After the battery is filled with acid when new, you should *never* add more acid unless the battery has been knocked over and the acid spilled out. As long as the acid has never spilled out of the cells, add only pure, fresh water, *never more acid*. Many people think that adding more acid will make a battery stronger. They are wrong, it will damage the battery.

The water used in the battery must be pure, clean and fresh or the battery life may be shortened. It is always best to use distilled water. *Never use water collected on a roof or metal surface and never use bottled water unless it is distilled.* If you cannot get distilled water, you can use rainwater that has never touched anything but clean plastic or glass.

Here is a good way to collect rainwater for batteries:

- Find a glass or plastic container that has never been used to store diesel fuel, gasoline (benzene), kerosene, cooking oil or other oily material.
- Clean the container carefully with fresh water and rinse well with more fresh water. Do not use soap.

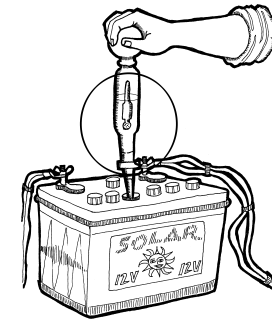

Take hydrometer readings regularly and always write them down so that you can tell if cells that are low today are regularly lower than the others. This means that the cells need an equalizing charge (see page 45).

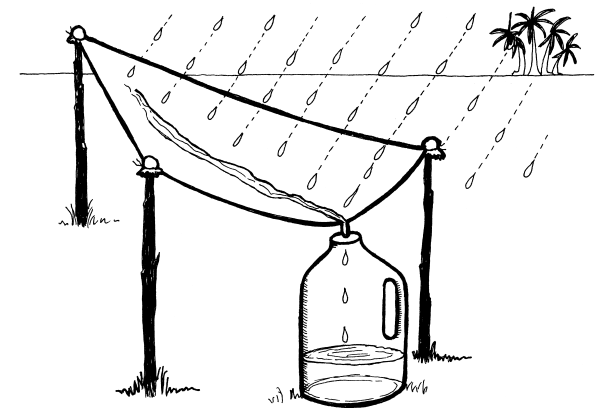

When distilled water is not available, if rainwater is collected on clean plastic and stored in a clean plastic or glass container, it can be used for batteries.

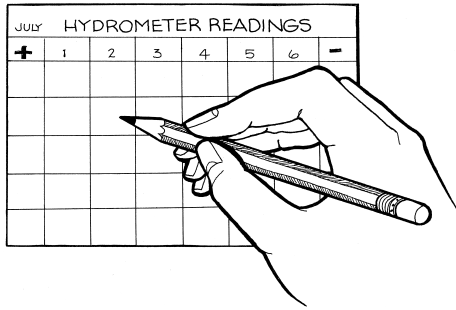

By keeping a record of hydrometer readings, you can tell if a cell begins to weaken and you can give it an equalizing charge to repair it.

If water has to be added more than once a month to all the battery cells, the system charge controller is probably not operating properly. It should be replaced or returned for adjustment or repair.



Do not smoke near batteries because explosive gases may be present in the cells.

- Drive three sticks into the ground in a place away from trees and the sea. The tops of the sticks should be about 15 cm (6 inches) higher than the container you have cleaned. The sticks should be spaced about 1 m (3 feet) apart. When it rains, stretch a sheet of clean plastic across the tops of the sticks, tying the plastic tightly to the top of one stick and loosely to the tops of the other two so that it sags between the two sticks about 10 cm (4 inches). The plastic will form a trough where the rain will collect and pour out at the lowest point where the container will be placed.
- Let the rain fall on the plastic for 10 to 15 minutes to clean it. Rinse the container with rainwater too.
- Place the container on the ground under the lowest part of the plastic sheet. The rain will be caught by the plastic sheet and directed into the container.
- When the rain stops or when the container is full, it should be capped with a plastic or cork cover and stored inside to stop dirt getting into the water. A metal cap should not be used. The pure water that has been collected should not be used for anything except filling the cells in solar batteries. When properly stored, it will last for years.

Do not fill the battery cells so that the water reaches the top of the fill holes. If you do, as the battery is charged, electrolyte will spill out and acid will spread over the top of the battery. The electrolyte should always cover the lead plates you can see as you look into the fill hole, but should not come up into the fill hole itself. There is usually a mark on the side of the battery or an indicator in the fill hole that shows the correct level for the electrolyte.

Battery caps must always be in place except when you are checking the battery. The caps have a small hole to let the cell breathe. If that hole is plugged, the cell may be damaged. If a cap is lost or broken and a proper replacement cap is not immediately available, use a small piece of plastic to cover the hole. Remember never to plug the hole tightly because the cell must have air to operate. Never use paper, wood, cork or metal to cover the fill holes, only plastic or glass.

If water has to be added more than once each month to all the battery cells, the system charge controller is probably not working properly. The controller should be replaced or returned for adjustment or repair.

If water has to be added often to one or two cells but not the rest of the cells, the battery is failing and it will probably have to be replaced soon.

## EQUALIZATION

---

When a battery begins to show different readings in different cells, it is beginning to fail. Sometimes the battery can be repaired by deliberate overcharging. This is called an equalizing charge.

To equalize the cells in a battery, you have to give them a slow, controlled overcharge. Because the charge controller is intended to prevent overcharge, it must be bypassed and the panels connected directly to the battery.

Starting with a charged battery, two sunny days should be enough for an equalizing charge to work. You can tell when equalization is taking place because many small bubbles will form in the cells, the terminal voltage will be above 15 V and the battery may be unusually warm. If the days you have chosen are not completely sunny, several days may be needed. During this time, lights and other electrical appliances should not be used.

Even if cells do not appear unbalanced, equalizing every six months is a good idea.

The battery will lose water quickly during equalization. Always refill the cells to the correct electrolyte level every day while the battery is equalizing.

## SAFETY NEAR BATTERIES

---

Although the voltage of a battery is not high enough to cause harm, if a piece of metal is placed across the terminals of a charged battery, there is enough power in the battery to produce a large, hot spark that could start a fire.

### CELL EQUALIZATION

When a battery is new, all the cells should have about the same capacity to be charged. As the battery ages, some of the cells may weaken. The weak cell usually gives a consistently lower hydrometer reading than the other cells in the battery.

If this problem continues for several months, the cell is likely to become permanently weaker than the rest.

If the problem is caught early and the battery is given an equalizing charge, then the weak cell may recover its capacity and not suffer permanent damage.

Some manufacturers recommend an equalizing charge at least once every six months. In practice, an equalizing charge is usually given only when there is evidence of one or more cells becoming weaker than the rest.



Battery acid in the eyes can cause blindness unless washed out quickly and thoroughly.



Never lay anything metal on top of a battery because shorted battery terminals can start a fire.

The acid in a battery is not strong enough to cause immediate burns to the skin and no harm will probably be done if it is washed off immediately. To remove the acid, lots of water must be used for washing. Fresh water is best, though sea water will do. But be very careful not to get sea water into a battery or it will be ruined. Acid in the eyes can cause damage and sometimes blindness. Do not look straight down into the fill hole while acid or water is being added. After handling, filling or testing a battery, be careful not to touch your eyes before washing your hands. If any acid gets into your eyes, wash them with lots of water by immersing your head in a bucket of water or, if possible, dunking in a pool.

When the battery is connected, it sometimes produces a gas that will explode if a flame is near. Never smoke, light matches, or use an open flame lantern near a battery, particularly when checking or filling the cells.

# Wiring

# 6

## INTRODUCTION

---

If a water system is installed using pipes that are too small, water pressure will be lost in the pipes. By the time the water reaches the user, the pressure may be so low that not enough water comes out to be useful. The reason for the loss of pressure is that the small pipe has too high a resistance and some of the pressure is used just keeping the water flowing in the pipe.

In an electrical system, if the wires are too small, electrical pressure (voltage) is lost and appliances may not get enough electricity to work properly. The reason for the loss of voltage is that the small wires have too high a resistance and some of the voltage is used just keeping the electricity flowing in the wires.

Wiring that is too small is a common reason for poor performance of solar PV systems. It is important to understand that the wiring used for a 12 V or 24 V solar installation must be much larger than wire used to carry the same amount of power at 240 V from a city electrical system.

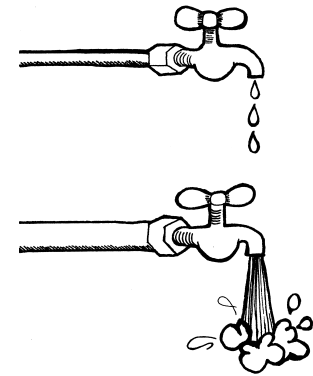

Small pipes lose more water pressure than larger pipes. Small wires lose more voltage than larger wires.

Wire connecting appliances in a solar installation must be larger than wire used for appliances with the same watt requirement using 240 V ac power.



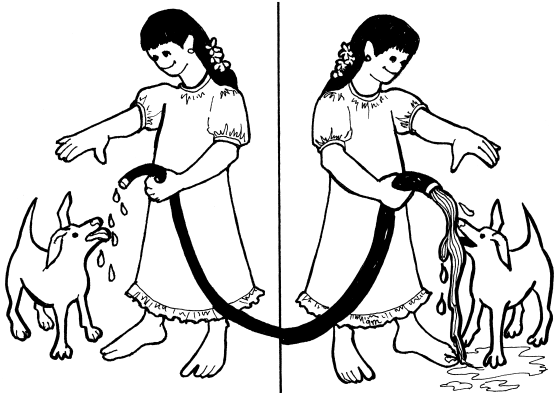

At the same pressure, more water flows through a large pipe than a small one. If a pipe is too small not enough water will flow.



At the same voltage, more electricity flows through a large wire than a small one. If a wire is too small not enough electricity will flow.

## RELATION OF SIZE TO POWER LOSS

*Pipe size.* Water flows easily through a large pipe but not through a small pipe. The smaller the pipe, the more difficult it is to force water through it. To make water flow through a pipe, there must be force behind it. That force is the water pressure. To move a certain amount of water each day through a large pipe takes less pressure than to move it through a small pipe. As the power needed to move the water is the pressure times the flow rate, a small pipe needs more power than a large pipe to move the same amount of water through the pipe in a day. Power costs money. Larger pipes can be installed to save power, but large pipes cost more than small ones. When designing a water system, the designer has to compare the cost of larger pipes with the cost of the extra power to force water through smaller pipes.

*Wire size.* The same problem arises with solar PV systems. The smaller the wire, the more electrical pressure (volts) are needed to force a certain current (amperes) through the wire. To get this higher voltage, more batteries and panels must be installed, usually at extra cost. If you use very large wires, the voltage needed to push the electricity through the wires is low, but the cost of the wires is much higher. The best size of wire will compromise between the cost of larger wire with low voltage losses and the cost of the extra panels and batteries to overcome the losses from cheaper, smaller wire.

## RELATION OF LENGTH TO POWER LOSS

*Pipe length.* The longer a pipe, the more difficult it is to force water through it. To move a certain amount of water each day through a short pipe takes less pressure than moving the water through a long pipe of the same size. As the power needed to

move the water is the pressure times the flow rate, using a long pipe will require more power to move the same amount of water than using a short one. Power costs money. To save power, pipes should be as short as possible.

*Wire length.* The same problem exists with solar PV systems. More electrical pressure (voltage) is needed to force a certain current (amperes) through a long wire than a short one of the same size. To get this increased voltage, more batteries and panels must be installed at extra cost. To save cost, wires should be kept as short as possible. Short wires save on wire cost and cause less power loss.

## VOLTAGE DROPS FROM WIRING

The reason for the power loss in wire is its resistance (ohms). It takes force (volts) to push electricity through a wire and the more resistance the wire has, the more force must be used. The voltage needed to push electricity through a wire is called the voltage drop of the wire. It is called voltage drop because the voltage at the appliance end of the wire is lower than the voltage at the battery end by the amount needed to push the electricity through the wire. The wire resistance causes a drop in voltage.

It takes more force to push a lot of electricity through a wire than to push a small amount. Therefore, the voltage drop in a wire increases as the current (amperes) increases. The exact voltage drop of the wire equals the amperes being pushed through the wire times the wire resistance in ohms.

An appliance requires a certain voltage and a certain number of amperes to work properly. The appliance determines the number of amperes that must flow in the wire connecting it to the battery. If the appliance cannot get enough amperes because the voltage is too low, it will not work properly and may be damaged.

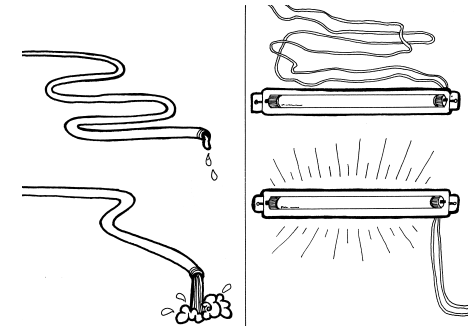

Pipes that are too long lose too much pressure. Wires that are too long lose too much voltage.

1 m of copper wire that is 1 mm<sup>2</sup> in size has a resistance of about 0.02 Ω. The total resistance of a wire can therefore be calculated by the formula:

$$\text{ohms} = 0.02 \times \text{metres} \div \text{size in mm}^2$$

As volts = amperes × ohms, the voltage drop in a wire can be calculated by the formula:

$$\text{volts lost} = \text{amperes} \times (0.02 \times \text{metres} \div \text{mm}^2)$$

The length of wire in a circuit is double the distance between the end points, so the number of metres of wire is twice the distance that the wire runs.

This is the formula for calculating wire size which gives a 0.5 V drop for any distance of wire run and current:

$$\text{mm}^2 = 0.08 \times \text{wire run in metres} \times \text{amperes}$$

The three things that determine the loss of voltage in a wire are:

- 1) the number of amperes flowing in the wire
- 2) the wire size (in mm<sup>2</sup>)
- 3) the wire length (in metres).

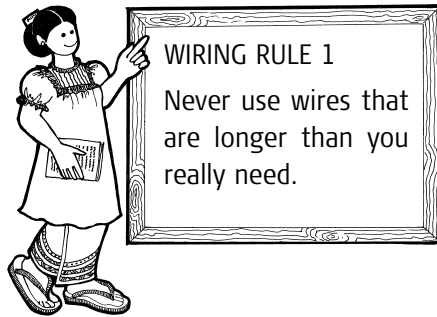

#### WIRING RULE 2

The maximum voltage drop for 12 V solar system wiring should not exceed 0.5 V. For a 24 V system, it should not exceed 1.0 V.

*Wire length and voltage drop.* Because wire resistance increases as wire length increases, the shorter the wire the better. If the voltage drop between the battery and an appliance is 2 V with a 10 m wire, shortening the wire to 5 m will cut the voltage drop in half to only 1 V. Not only does a shorter wire make more volts available to the appliance, it also cuts the cost of the wire, so a double advantage is gained. This leads to **Wiring Rule 1:** Wires should be as short as is practical.

*Wire size and voltage drop.* Because wire resistance decreases as wire size increases, the voltage drop in the wires goes down as wire size goes up. Doubling the size of the wire cuts the wire voltage loss in half. But doubling the wire size will increase the cost of the wire. One solution is to allow the wire to lose some voltage but not so much as to cause problems with the appliances. This leads to **Wiring Rule 2:** The voltage drop in a 12 V system should not be greater than 0.5 V. In a 24 V system it should not be greater than 1 V.

## TYPES OF WIRE

---

There are several different types of wire. It is important to use the correct type of wire when installing a solar PV system.

### ■ Conductor type

---

The metal core that carries the electricity is called the conductor. Although wires are sometimes made with aluminium conductors, wire used for home and small commercial applications is always copper. Even if aluminium wire is available at no cost, never use it in house wiring because unless it is correctly installed with special connectors, which are difficult to obtain, it will not work well or last long.

For house wiring, solid copper wire is often used. It consists of a single solid copper conductor inside an insulating sleeve. Solid wire is usually the cheapest but it is inflexible and if bent back and forth enough times it will break.

Wire is often made up of many small strands of wires all bunched together inside the insulating sleeve. This is called stranded wire. Though each strand is very small, enough strands are bunched together to make the total wire area equal to that of a solid wire. If each strand is, for example,  $0.1 \text{ mm}^2$  in size, then 25 strands will be used in a  $2.5 \text{ mm}^2$  wire. The main advantage of stranded wire is its flexibility. The more strands in the conductor, the more flexible the wire. Most appliance power cords have a stranded wire. Very large electrical wires are also stranded because a single solid wire would be too difficult to bend.

Electrically, there is no difference between equal sizes of stranded and solid wire. Solid wire is cheaper and good for permanent installations. Stranded wire is usually best for any application where the wire is not permanently fixed in place.

## ■ Insulation

Insulation on a wire is mainly intended to prevent accidental electrical connections so that no electricity is lost through leakage to the material surrounding the wire. Insulation is also for safety. At the low voltages of a PV system, an electric shock is not likely but burns or a house fire can be caused if poorly insulated wires touch and cause a short circuit.

Another use of insulation in some wires is to combine several conductors into one unit. All electrical circuits require one wire going to the appliance from the power source and another wire returning. So it is common for house wiring to include two separate conductors combined into one insulating sheath. This is called two-conductor cable. Three conductors or more can also be combined into one insulating sheath. For PV systems two conductors are usually enough. Multiple-conductor cable has two layers of insulation. The outside insulation holds the different wires together and the inside insulation forms a layer around each individual wire. For house wiring, two-conductor cable is more convenient to install than two single-conductor wires.

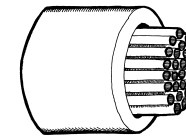

Many small copper wires (strands)

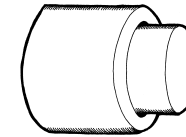

One big solid copper wire

Some wire is made from many small wires bunched together in an insulating sleeve. This is called stranded wire and is used where flexibility is needed. Other wire is made from one single solid conductor. This wire is cheaper but may break if bent too many times in the same place.

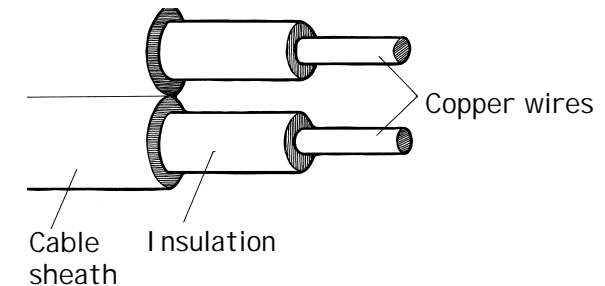

A cable has more than one wire inside.

### WIRING RULE 3

Always use the right kind of wire for the job. Buried wire must have insulation rated for underground. Wire exposed to sunlight must have exterior grade insulation. Wire with interior grade insulation should not be buried nor exposed to the sun for long.

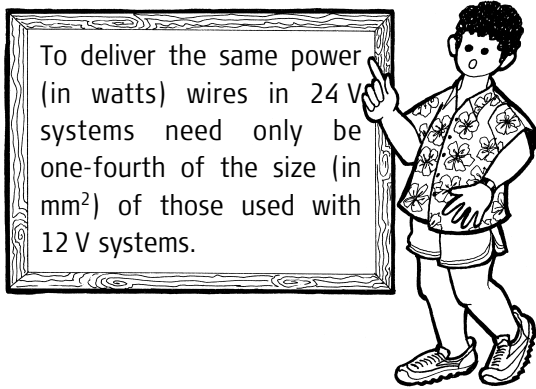

To calculate the exact wire size needed in a 12 V appliance circuit so that no more than a 0.5 V drop occurs, you can use the formula:

$$\text{mm}^2 = 0.08 \times \text{amperes} \times \text{metres}$$

where  $\text{mm}^2$  is the size of the wire, amperes is the number of amperes which will flow through the wire, and metres is the length of the wire path between the battery and the appliance.

For example, for a simple lighting circuit with a lamp that needs 4 A to operate, located 5 m from the battery, you would have:

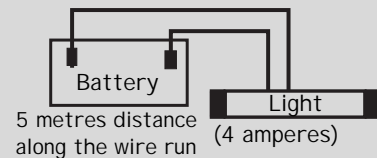

Note that you must use the length of the actual path the wire will follow.

So the calculation is:

$$\text{mm}^2 = 0.08 \times 4 \text{ A} \times 5 \text{ m} = 1.6$$

and if there is to be no more than a 0.5 V loss in the wire, a wire size of at least  $1.6 \text{ mm}^2$  is required.

Insulation also protects the wires from damage. Heavy insulation, resistant to wear, is used for wiring that will be moved often or may be stepped on or run over by vehicles. Special insulation is needed for wires that will be buried or exposed to sunlight and the weather.

When buying wire, make sure that the insulation is right for the job. If the wire will be exposed to the weather, as when it is used for connecting solar panels, the insulation must be designed for exposure to sunlight and rain. Standard indoor house wiring will harden and crack open if exposed to sunlight for long periods. If the wire will be buried, the insulation must be designed to resist the fungus and moisture always present in the ground. Standard indoor house wiring will be ruined by long burial. This leads to **Wiring Rule 3**: Always use the right kind of wire for the job.

## CHOOSING THE CORRECT SIZE OF WIRE

At the end of this chapter are four tables. These tables can be used to find a suitable size of wire to connect panels or appliances to batteries.

Two of the tables are for use with 12 V systems and two are for 24 V systems. Before using a table, check that it is the right one for the voltage in your system.

Looking at the tables, three things must be known in order to choose the correct wire size:

- the voltage of the PV system battery (12 V or 24 V)
- the distance in metres along the path of the wire
- the number of amperes that must flow through the wire to operate the appliance connected to it.

**Battery voltage.** The battery voltage for most solar PV systems will be either 12 V or 24 V. If the voltage is not 12 V or 24 V these tables should not be used.

*Distance along the path of the wire.* The length must be measured along the actual path the wire follows all the way to the battery.

To use the wire tables, first select the 12 V or 24 V table that fits your system. The exact size tables are mainly used for large systems requiring wires larger than 4 mm<sup>2</sup>. They should also be used when one wiring circuit feeds more than one appliance.

### ■ Appliance to battery

It is very easy to use the wire sizing tables when a single appliance is connected by a wire to the battery. First find the ampere rating or watt rating of the appliance. This is usually shown on the label although sometimes it can only be found on specification sheets packed with the appliance. The amperes used by an appliance can also be measured while it is in use with an ammeter.

Starting at the top left of the table, move down the watts or amperes column until you find the first row with the number of watts or amperes equal to, or higher than, the appliance rating.

Next, measure or closely estimate the total distance the wire must run between the battery and the appliance. Make sure that you allow for any extra wire that goes to switches, and the extra length needed to go around doors, windows or to make other detours.

Then, in the table, go across the row with the correct watt/ampere value until you reach a column for a wire length equal to, or longer than, the wire length you need.

Read the wire size in mm<sup>2</sup> in the box where the wire length column and the watt/ampere row meet. If you are using an exact size table, then the exact number of mm<sup>2</sup> that will work is given. If you are using the standard wire table, then the standard metric wire size that fits the application is shown. You can use the wire size shown or a larger size. Never use a smaller size.

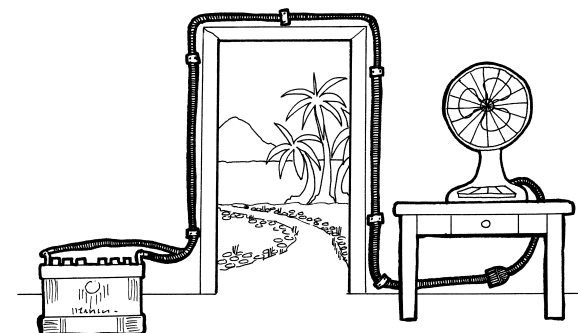

Distance is always measured along the actual path the wire follows in the installation. Side branches to switches or extra wire needed to go around doors and windows must be included in the total distance between the battery and the appliance. Even though the wire you are connecting may go to a controller instead of all the way to the battery, the distance for working out wire size must be measured all the way from the appliance to the battery.

To carry the same amperes without increasing the voltage drop, wires that are twice as long must be twice the size in mm<sup>2</sup>.

The four wire sizing tables at the end of this chapter are in two groups, one for 12 V systems and the other for 24 V systems.

In each voltage group, the first table gives the exact minimum size of wire that can be used for different lengths of wire run and for carrying different numbers of amperes. The main use of this table is to calculate the minimum wire size needed when more than one appliance is connected at different points along a wire. It is also useful when the wire to be used is measured in units that are not mm<sup>2</sup> but can be converted from those given in the table (for example American Wire Gauge or AWG).

The second table in each group gives the standard metric wire size for connecting one appliance of a given wattage at a given distance from the battery (wire length).

As well as for connecting appliances to the battery, both tables can also be used to select the correct wire size for connecting PV panels to the battery.

### ■ More than one appliance connected to one wire

---

It is not always the case that only one appliance is connected to a wire. Suppose you have three appliances connected to one wire. Suppose that the first appliance is a television that needs 60 W of power and it is 2 m away from a 12 V battery. The second appliance is a fan that needs 24 W and is 4 m from the battery. The last appliance is a light that needs 13 W and is 7 m from the battery.

In this example, the wire is connected in three sections. Battery to appliance one (television), appliance one to appliance two (television to fan) and appliance two to appliance three (fan to light). The first section (battery to television) carries not only the power for the television but also electricity that will flow on to the fan and light. The second section (television to fan) does not carry power to the television but does carry the power for both the fan and the light. The third section (fan to light) carries no power to either the television or the fan, only power for the light.

Step one is to use the table to find the exact wire size needed for each appliance if each appliance was connected by itself. For the television that is 2 m from the battery and uses 60 W, a wire size of 0.80 mm<sup>2</sup> is needed. For the fan 4 m from the battery and using 24 W, a wire of 0.64 mm<sup>2</sup> is needed. For the 13 W light 7 m from the battery, a wire of 0.61 mm<sup>2</sup> is needed.

Step two is to combine the multiple wire sizes into one. The wire from the battery to the television will have to be large enough to carry power to all three appliances. It will need to be 0.80 plus 0.64 plus 0.61 mm<sup>2</sup> in size, or 2.05 mm<sup>2</sup>. The section of wire between the television and the fan will be carrying the power needed by the fan and the light so the minimum wire size needed in this section will be 0.64 + 0.61 = 1.25 mm<sup>2</sup>. Finally, the section between the fan and the light will only be carrying power for the light, so that wire must not be smaller than 0.61 mm<sup>2</sup>. While it is technically correct to connect the three appliances using the three different wire sizes, the largest of the three sizes is usually used for all the connections. In this case, the smallest acceptable size would be 2.5 mm<sup>2</sup> wire.

This method can be used for any number of appliances by dividing the circuit into the same number of sections as there are appliances.

Although you can use the exact wire sizes from the table, you can also use any larger wire. If a larger wire is used, the actual power loss is less so there will be an improvement in the operation of the PV system.

The two most common metric wire sizes are 1.5 mm<sup>2</sup> and 2.5 mm<sup>2</sup>. The difference in cost between the two wire sizes is not large compared with the overall cost of the PV system, but the losses in the smaller wire are much higher. For the best performance, use the 2.5 mm<sup>2</sup> size even if a smaller wire is given in the table. This leads to **Wiring Rule 4**: Do not use wire smaller than 2.5 mm<sup>2</sup> in PV system wiring.

Note that when you double the distance that the wire must run, you have to double the size of the wire to keep the voltage loss the same. This means that you can use the table for longer wire than listed. If you need to know the size of wire to run for 30 m, you can look in the table for the size of wire to run for 15 m and double the size. In the same way, you can find wire sizes for larger amperes than given in the table. Doubling the amperes for the same wire run means that you will need double the wire size to keep the losses the same. So if you want to know the wire size for a 50 A load, look in the 25 A row of the table and double the wire size shown.

## ■ Appliances with motors

The watt or ampere rating on an appliance shows its electricity use while in normal, continuous operation. For example, a refrigerator may show a power requirement of 60 W at 12 V. This means when it is running continuously, it will need to receive 5 A of current from the battery. Electric motors, however, require extra current to start. When an electric motor is first turned on it may require several times the amperes it uses when running. The voltage drop in the wire increases as the amperes through the wire increases. Therefore, a motor that is starting and drawing extra amperes from the battery may cause such a large voltage drop in the

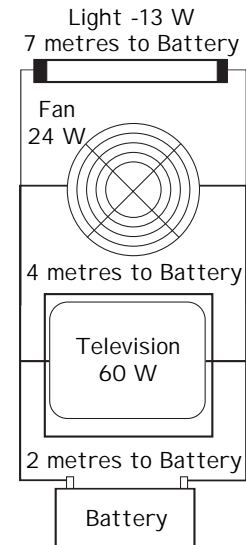

More than one appliance on a wire run.



### WIRING RULE 4

Do not use wire smaller than 2.5 mm<sup>2</sup> or 12 AWG in any installation.

### WIRING RULE 5

Wires from the battery to any appliance with a motor (refrigerator, pump, washing machine, etc.) must be able to carry currents that are at least double the usual amperes needed. When using the tables for appliances with a motor, enter the table at the row with twice the watt or ampere rating.





The amperes from solar panels change with the amount of energy from the sun and the Wp (Watt peak) rating of the panels. The loss in the wires increases as the amperes increase. So to make sure that the actual wire losses are acceptable, you should calculate the wire size based on the maximum number of amperes that will come from the panels. As the Wp of the panels is known and almost all panels made today are designed for 12 V, you can estimate the maximum amperes from a panel by remembering that watts = volts × amperes. So amperes must = watts ÷ volts. To estimate the amperes from a panel, divide the Wp by 12 V.

### Example 1

Your panels are rated as 110 Wp. You should assume the maximum amperes to be 9.2 A:  
110 divided by 12 is about 9.2 A.

wire that it can cause problems with the appliance. This is particularly true when the battery is partially discharged and its voltage low. To prevent this problem, wires running to appliances with motors (refrigerators, washers and pumps, for example) should be sized for at least twice as many watts or amperes as the appliance normally requires when running.

This leads to **Wiring Rule 5**: Wires from the battery to any appliance with a motor have to carry currents that are at least double the usual amperes needed.

An exception to this rule is the wire running to electric fans. Fans do not require the extra starting current and therefore do not need the oversized wire.

If the table shows a wire size larger than is available, several smaller wires can be combined into one large one. So if the table shows 10 mm<sup>2</sup> wire, four 2.5 mm<sup>2</sup> wires can be run together from the battery to the appliance.

## ■ Panel to battery connections

Problems of voltage drop can occur in the wires connecting solar panels to batteries.

The number of amperes that the wire must carry is not constant. It changes with the amount of charge in the battery and the brightness of the sun. The wire size should be large enough to pass the *maximum* amperes that the panels can produce. The maximum panel amperes is often printed on the panel or in the panel specifications sheet as the  $I_{sc}$  of the panel. If the actual maximum panel amperes is not known, remember that watts equals volts times amperes. So the panel peak amperes will be its peak watts divided by its voltage. As almost all solar panels are designed to charge 12 V batteries, if you divide the peak watts by 12, you will usually get a reasonable estimate of the peak amperes. Thus a 72 Wp panel (peak watt rating as shown in the panel specification) could be expected to provide a maximum ampere output of 72 W divided by 12 V, or 6 A.

For panel wiring you can use either the exact size table or the standard size table. For small systems, the standard size table is usually best. But for large systems that require large wires, the exact size table is more accurate.

If the table gives a wire size larger than is available, several smaller wires can be combined into one large one. So if the table gives 10 mm<sup>2</sup> wire, four 2.5 mm<sup>2</sup> wires can be run together from the panels to the battery.

Note that when you double the distance that the wire must run, you have to double the size of the wire to keep the voltage loss the same. This means that you can use the table for longer wire than listed. If you need to know the size of wire to run for 30 m, you can look in the table for the size of wire to run for 15 m and double the size.

### ■ Using the tables for non-European wire

While wire sizes measured in mm<sup>2</sup> and wire lengths measured in metres are the most common around the world, other wire size and length systems exist. To use the tables with these measurement systems, first convert wire length to metres and look up the wire size in mm<sup>2</sup> from the tables. To find the wire size in a special measuring system, a conversion table between mm<sup>2</sup> and the wire gauging scheme must be used. For example, in the United States, the measure of length is the foot. To convert feet to metres, divide by 3.28. The wire size system is called American Wire Gauge (AWG) and a table converting AWG to mm<sup>2</sup> is given on page 60.

## CONNECTING WIRES

Connections in a PV system have to be very good because the electrical pressure (voltage) available to push the electricity through the connection is low. In a regular ac system, the voltage is 10 to 20 times higher than in a solar system. So wiring connections that work well for regular ac systems may not work well for a solar system. Connecting wires by twisting them together may work for a short time, but the twisting gradually loosens and corrodes and, after a while, the connection will have a high loss and cause problems.

### Example 2

A 24 V solar system uses 14 panels to power a health centre. The 42 Wp panels are mounted on the roof and the wire connecting the panels to the battery will be 12 m long. Only 2.5 mm<sup>2</sup> wire is available for use. Using the 24 V wire table, what wire size is needed? How would the panels be wired?

Select the 24 V exact size table. The total Wp will be  $14 \times 42 = 588$  Wp. Go down the watts column to 600 W. Go across that row to 12 m distance. You will see that the minimum wire size is 12 mm<sup>2</sup>.

Five 2.5 mm<sup>2</sup> wires will have to be grouped together to provide a large enough wire to meet the needs of the system.

As there will be seven pairs of panels in the array, a reasonable wiring solution would be to use one 2.5 mm<sup>2</sup> cable per pair of panels. This would provide a total wire size of  $7 \times 2.5 = 17.5$  mm<sup>2</sup> and a very low voltage drop.

Two important rules for connecting wires in a solar system:

- 1) Always use a screw-type connector.
- 2) Always tighten the screws firmly.



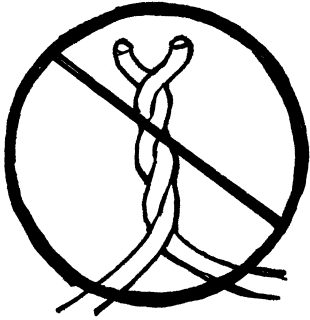

Never twist wires together for a connection.

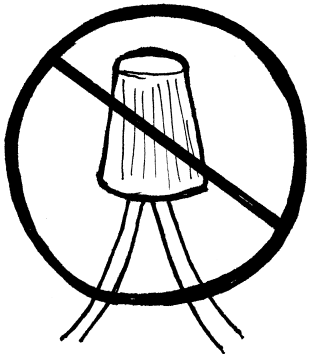

Wire nuts will not provide a good connection.

In regular ac systems, wires are often joined together by placing the two wires side by side then screwing a 'wire nut' on to the wires. The wire nut does keep the wires tightly together but corrosion can still be a long-term problem, especially in the tropics. So wire nuts should not be used for PV system connections.

Soldered connections or crimped connections can be used if done properly, but it is often difficult to find the right tools to make a good connection. Making proper crimped connections also takes special training and experience. So it is usually best to avoid soldered and crimped connections.

For solar installations, the only reliable way to connect wires is by using a screw-type connector. The screw can be tightened to the point where corrosion cannot occur and the connection will remain good. Also, it is easy to clean screw-type connectors, so even if corrosion occurs it can be removed without much difficulty.

## BATTERY CONNECTIONS

---

The connections to the battery are especially important as all the energy for charging the battery and all the energy for operating the appliances goes through the connections. Battery connections should always be of a screw type. Never use spring clips or wrap the wire around the terminals in order to make the connections. The best connections are made with screws that go through the battery terminal. The compression connectors usually used on vehicle batteries do not work well in the long term. They will corrode and will need cleaning every six months or so if electricity losses are to be kept low. When you have to use a vehicle battery, it is better to drill a hole through the terminal and use a bolt and nut to connect the wire than to use a compression connector as used for vehicles.

## PANEL CONNECTIONS

The connections to the solar panel are also very important. Almost all solar panels have a screw-type connector that provides a good connection. However, the screws often gradually loosen over time and it is important to clean and tighten the panel connections at least once a year if losses are to be kept low. Avoid using panels that do not have screw connections.

## WIRE TABLES

### ■ Standard wire tables

To simplify the calculation of wire size for circuits that only include the battery and one appliance or the battery and the panels, tables for 12 V and 24 V systems are provided that show the standard wire size to use.

Enter the table with either the amperes or watts of your appliance. Go down the ampere or watts column until you reach either the exact number or the number just greater than the Wp of the panels or the watts load for the appliance. Go across that row until you reach the column that shows the wire length in metres between the battery and the panel or the battery and the appliance you wish to connect. The number in that box is the size of wire in mm<sup>2</sup> that you will need to install.

### ■ Exact size tables

The 12 V and 24 V exact size tables give the exact wire size in mm<sup>2</sup> that is the minimum size to use. The value is obtained in the same way as the other tables. Go down the watts or amperes column to the exact value or the closest value above it and across to the column that shows the

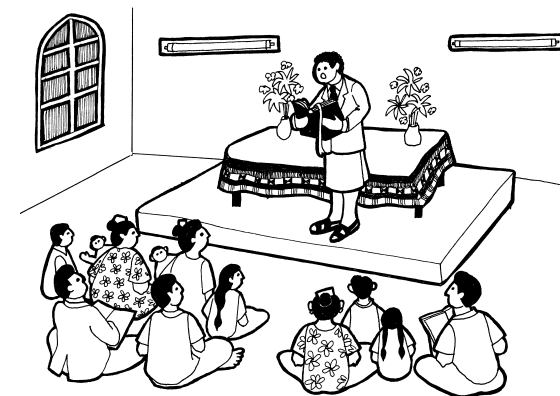

Community buildings usually have many lights. It is best to run separate wires for each light and provide a switch for each light. Having many lights on one switch may not work well. Also, to save the battery it is better to turn on only those lights that are really needed. You cannot do that if all lights are on a single switch.

Battery connections should never be made with spring clips. Use only screw-type connectors.

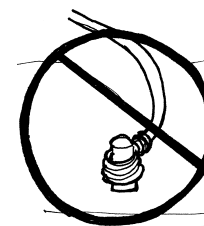
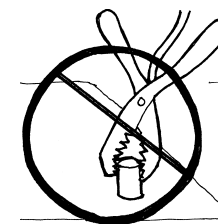

Battery connections should never have wires wrapped around the post. Use only screw-type connectors.

American Wire Gauge  
metric (mm<sup>2</sup>) equivalents

4 AWG = 21.1 mm<sup>2</sup>

6 AWG = 13.4 mm<sup>2</sup>

8 AWG = 8.41 mm<sup>2</sup>

10 AWG = 5.28 mm<sup>2</sup>

12 AWG = 3.32 mm<sup>2</sup>

14 AWG = 2.09 mm<sup>2</sup>

16 AWG = 1.32 mm<sup>2</sup>

For 12 V solar installations, the smallest wire that should be used is 12 AWG for connecting appliances and 10 AWG for connecting panels.

wire length in metres. This gives the exact minimum wire size needed. This value is important for calculating the correct wire size to use when several appliances are connected to the same wiring circuit. These tables are also useful when very large wire sizes are needed and you have to join several wires together.

### ■ Wiring motors

---

Always remember to double the wire size shown in the tables if you are connecting an appliance with a motor that starts under load, such as a refrigerator, freezer, washer or pump.

## 12 V exact size table – for sizing wire to multiple appliances or for connecting solar panels

Appliance load or panel Wp	Distance between battery and appliance (m)															
	1	2	3	4	5	6	7	8	9	10	11	12	13	14	15	
Wp or W	A	Exact wire size for no more than a 0.5 V voltage drop (mm <sup>2</sup> )														
6	0.5	0.04	0.08	0.12	0.16	0.20	0.24	0.28	0.32	0.36	0.40	0.44	0.48	0.52	0.56	0.60
10	0.8	0.07	0.13	0.20	0.27	0.33	0.40	0.47	0.53	0.60	0.67	0.73	0.80	0.87	0.93	1.00
12	1.0	0.08	0.16	0.24	0.32	0.40	0.48	0.56	0.64	0.72	0.80	0.88	0.96	1.04	1.12	1.20
13	1.1	0.09	0.17	0.26	0.35	0.43	0.52	0.61	0.69	0.78	0.87	0.95	1.04	1.13	1.21	1.30
15	1.3	0.10	0.20	0.30	0.40	0.50	0.60	0.70	0.80	0.90	1.00	1.10	1.20	1.30	1.40	1.50
18	1.5	0.12	0.24	0.36	0.48	0.60	0.72	0.84	0.96	1.08	1.20	1.32	1.44	1.56	1.68	1.80
20	1.7	0.13	0.27	0.40	0.53	0.67	0.80	0.93	1.07	1.20	1.33	1.47	1.60	1.73	1.87	2.00
22	1.8	0.15	0.29	0.44	0.59	0.73	0.88	1.03	1.17	1.32	1.47	1.61	1.76	1.91	2.05	2.20
24	2.0	0.16	0.32	0.48	0.64	0.80	0.96	1.12	1.28	1.44	1.60	1.76	1.92	2.08	2.24	2.40
28	2.3	0.19	0.37	0.56	0.75	0.93	1.12	1.31	1.49	1.68	1.87	2.05	2.24	2.43	2.61	2.80
30	2.5	0.20	0.40	0.60	0.80	1.00	1.20	1.40	1.60	1.80	2.00	2.20	2.40	2.60	2.80	3.00
32	2.7	0.21	0.43	0.64	0.85	1.07	1.28	1.49	1.71	1.92	2.13	2.35	2.56	2.77	2.99	3.20
34	2.8	0.23	0.45	0.68	0.91	1.13	1.36	1.59	1.81	2.04	2.27	2.49	2.72	2.95	3.17	3.40
36	3.0	0.24	0.48	0.72	0.96	1.20	1.44	1.68	1.92	2.16	2.40	2.64	2.88	3.12	3.36	3.60
38	3.2	0.25	0.51	0.76	1.01	1.27	1.52	1.77	2.03	2.28	2.53	2.79	3.04	3.29	3.55	3.80
40	3.3	0.27	0.53	0.80	1.07	1.33	1.60	1.87	2.13	2.40	2.67	2.93	3.20	3.47	3.73	4.00
45	3.8	0.30	0.60	0.90	1.20	1.50	1.80	2.10	2.40	2.70	3.00	3.30	3.60	3.90	4.20	4.50
50	4.2	0.33	0.67	1.00	1.33	1.67	2.00	2.33	2.67	3.00	3.33	3.67	4.00	4.33	4.67	5.00
55	4.6	0.37	0.73	1.10	1.47	1.83	2.20	2.57	2.93	3.30	3.67	4.03	4.40	4.77	5.13	5.50
60	5.0	0.40	0.80	1.20	1.60	2.00	2.40	2.80	3.20	3.60	4.00	4.40	4.80	5.20	5.60	6.00
65	5.4	0.43	0.87	1.30	1.73	2.17	2.60	3.03	3.47	3.90	4.33	4.77	5.20	5.63	6.07	6.50
70	5.8	0.47	0.93	1.40	1.87	2.33	2.80	3.27	3.73	4.20	4.67	5.13	5.60	6.07	6.53	7.00
75	6.3	0.50	1.00	1.50	2.00	2.50	3.00	3.50	4.00	4.50	5.00	5.50	6.00	6.50	7.00	7.50
80	6.7	0.53	1.07	1.60	2.13	2.67	3.20	3.73	4.27	4.80	5.33	5.87	6.40	6.93	7.47	8.00
85	7.1	0.57	1.13	1.70	2.27	2.83	3.40	3.97	4.53	5.10	5.67	6.23	6.80	7.37	7.93	8.50
90	7.5	0.60	1.20	1.80	2.40	3.00	3.60	4.20	4.80	5.40	6.00	6.60	7.20	7.80	8.40	9.00
100	8.3	0.67	1.33	2.00	2.67	3.33	4.00	4.67	5.33	6.00	6.67	7.33	8.00	8.67	9.33	10.00
110	9.2	0.73	1.47	2.20	2.93	3.67	4.40	5.13	5.87	6.60	7.33	8.07	8.80	9.53	10.27	11.00
120	10.0	0.80	1.60	2.40	3.20	4.00	4.80	5.60	6.40	7.20	8.00	8.80	9.60	10.40	11.20	12.00
130	10.8	0.87	1.73	2.60	3.47	4.33	5.20	6.07	6.93	7.80	8.67	9.53	10.40	11.27	12.13	13.00
140	11.7	0.93	1.87	2.80	3.73	4.67	5.60	6.53	7.47	8.40	9.33	10.27	11.20	12.13	13.07	14.00
150	12.5	1.00	2.00	3.00	4.00	5.00	6.00	7.00	8.00	9.00	10.00	11.00	12.00	13.00	14.00	15.00
160	13.3	1.07	2.13	3.20	4.27	5.33	6.40	7.47	8.53	9.60	10.67	11.73	12.80	13.87	14.93	16.00
170	14.2	1.13	2.27	3.40	4.53	5.67	6.80	7.93	9.07	10.20	11.33	12.47	13.60	14.73	15.87	17.00
180	15.0	1.20	2.40	3.60	4.80	6.00	7.20	8.40	9.60	10.80	12.00	13.20	14.40	15.60	16.80	18.00
190	15.8	1.27	2.53	3.80	5.07	6.33	7.60	8.87	10.13	11.40	12.67	13.93	15.20	16.47	17.73	19.00
200	16.7	1.33	2.67	4.00	5.33	6.67	8.00	9.33	10.67	12.00	13.33	14.67	16.00	17.33	18.67	20.00
220	18.3	1.47	2.93	4.40	5.87	7.33	8.80	10.27	11.73	13.20	14.67	16.13	17.60	19.07	20.53	22.00
240	20.0	1.60	3.20	4.80	6.40	8.00	9.60	11.20	12.80	14.40	16.00	17.60	19.20	20.80	22.40	24.00
260	21.7	1.73	3.47	5.20	6.93	8.67	10.40	12.13	13.87	15.60	17.33	19.07	20.80	22.53	24.27	26.00
280	23.3	1.87	3.73	5.60	7.47	9.33	11.20	13.07	14.93	16.80	18.67	20.53	22.40	24.27	26.13	28.00
300	25.0	2.00	4.00	6.00	8.00	10.00	12.00	14.00	16.00	18.00	20.00	22.00	24.00	26.00	28.00	30.00

**For connecting panels:** Enter the table using the total Wp panel capacity as watt load. For example, for a single panel with 75 Wp capacity, go to the row for 75 W. If the exact capacity is not shown, use the next larger row (80 W). For a 42 Wp set of panels, use the row for 45 W, and so on.

**IMPORTANT:** If the appliance to be connected has a motor (refrigerator, freezer, pump, etc.) so starts under load, the wire size given in the table should be doubled. The motors of fans do not start under load so a larger wire is not needed. This table is mainly for circuits with several appliances on one wire. To find the wire size to each appliance follow these steps:

- 1) Find the watts required by each appliance and the distance along the wire path from the battery to each appliance.
- 2) Use the table to find the minimum wire size for each appliance.
- 3) The wire from the battery to the first appliance must be no smaller than the sum of the wire sizes to all the appliances.
- 4) The wire from the first appliance to the second must be no smaller than the sum of the wire sizes to the second and later appliances.
- 5) The wire from the second appliance to the third must be no smaller than the sum of the wire sizes to the third and later appliances.

**12 V wire sizing table – standard wire (metric)**

Load		Distance between battery and load (m)																			
		1	2	3	4	5	6	7	8	9	10	11	12	13	14	15	16	17	18	19	20
W	A	Standard size wire needed (mm <sup>2</sup> )																			
6	0.5	2.5	2.5	2.5	2.5	2.5	2.5	2.5	2.5	2.5	2.5	2.5	2.5	2.5	2.5	2.5	2.5	2.5	2.5	2.5	2.5
10	0.8	2.5	2.5	2.5	2.5	2.5	2.5	2.5	2.5	2.5	2.5	2.5	2.5	2.5	2.5	2.5	2.5	2.5	2.5	2.5	2.5
12	1.0	2.5	2.5	2.5	2.5	2.5	2.5	2.5	2.5	2.5	2.5	2.5	2.5	2.5	2.5	2.5	2.5	2.5	2.5	2.5	2.5
13	1.1	2.5	2.5	2.5	2.5	2.5	2.5	2.5	2.5	2.5	2.5	2.5	2.5	2.5	2.5	2.5	2.5	2.5	2.5	2.5	2.5
15	1.3	2.5	2.5	2.5	2.5	2.5	2.5	2.5	2.5	2.5	2.5	2.5	2.5	2.5	2.5	2.5	2.5	2.5	2.5	2.5	2.5
18	1.5	2.5	2.5	2.5	2.5	2.5	2.5	2.5	2.5	2.5	2.5	2.5	2.5	2.5	2.5	2.5	2.5	2.5	2.5	2.5	2.5
20	1.7	2.5	2.5	2.5	2.5	2.5	2.5	2.5	2.5	2.5	2.5	2.5	2.5	2.5	2.5	2.5	2.5	2.5	2.5	4	4
22	1.8	2.5	2.5	2.5	2.5	2.5	2.5	2.5	2.5	2.5	2.5	2.5	2.5	2.5	2.5	2.5	2.5	2.5	4	4	4
24	2.0	2.5	2.5	2.5	2.5	2.5	2.5	2.5	2.5	2.5	2.5	2.5	2.5	2.5	2.5	2.5	4	4	4	4	4
28	2.3	2.5	2.5	2.5	2.5	2.5	2.5	2.5	2.5	2.5	2.5	2.5	2.5	2.5	4	4	4	4	4	4	4
30	2.5	2.5	2.5	2.5	2.5	2.5	2.5	2.5	2.5	2.5	2.5	2.5	2.5	4	4	4	4	4	4	4	4
32	2.7	2.5	2.5	2.5	2.5	2.5	2.5	2.5	2.5	2.5	2.5	2.5	4	4	4	4	4	4	4	6	6
34	2.8	2.5	2.5	2.5	2.5	2.5	2.5	2.5	2.5	2.5	2.5	2.5	4	4	4	4	4	4	6	6	6
36	3.0	2.5	2.5	2.5	2.5	2.5	2.5	2.5	2.5	2.5	2.5	4	4	4	4	4	4	6	6	6	6
38	3.2	2.5	2.5	2.5	2.5	2.5	2.5	2.5	2.5	2.5	4	4	4	4	4	4	6	6	6	6	6
40	3.3	2.5	2.5	2.5	2.5	2.5	2.5	2.5	2.5	2.5	4	4	4	4	4	6	6	6	6	6	6
45	3.8	2.5	2.5	2.5	2.5	2.5	2.5	2.5	2.5	4	4	4	4	4	6	6	6	6	6	6	6
48	4.0	2.5	2.5	2.5	2.5	2.5	2.5	2.5	4	4	4	4	4	6	6	6	6	6	6	8	8
50	4.2	2.5	2.5	2.5	2.5	2.5	2.5	2.5	4	4	4	4	4	6	6	6	6	6	6	8	8
55	4.6	2.5	2.5	2.5	2.5	2.5	2.5	4	4	4	4	6	6	6	6	6	6	8	8	8	8
60	5.0	2.5	2.5	2.5	2.5	2.5	2.5	4	4	4	4	6	6	6	6	6	8	8	8	8	8
65	5.4	2.5	2.5	2.5	2.5	2.5	4	4	4	4	6	6	6	6	8	8	8	8	8	10	10
70	5.8	2.5	2.5	2.5	2.5	2.5	4	4	4	6	6	6	6	8	8	8	8	8	10	10	10
72	6.0	2.5	2.5	2.5	2.5	2.5	4	4	4	6	6	6	6	8	8	8	8	10	10	10	10
75	6.3	2.5	2.5	2.5	2.5	2.5	4	4	4	6	6	6	6	8	8	8	8	10	10	10	10
80	6.7	2.5	2.5	2.5	2.5	4	4	4	6	6	6	6	8	8	8	8	10	10	10	12	12
84	7.0	2.5	2.5	2.5	2.5	4	4	4	6	6	6	8	8	8	8	10	10	10	12	12	12
85	7.1	2.5	2.5	2.5	2.5	4	4	4	6	6	6	8	8	8	8	10	10	10	12	12	12
90	7.5	2.5	2.5	2.5	2.5	4	4	6	6	6	6	8	8	8	10	10	10	12	12	12	12
96	8.0	2.5	2.5	2.5	4	4	4	6	6	6	8	8	8	10	10	10	12	12	12	14	14
100	8.3	2.5	2.5	2.5	4	4	4	6	6	6	8	8	8	10	10	10	12	12	12	14	14
108	9.0	2.5	2.5	2.5	4	4	6	6	6	8	8	8	10	10	12	12	12	14	14	14	16
110	9.2	2.5	2.5	2.5	4	4	6	6	6	8	8	10	10	10	12	12	12	14	14	14	16
120	10.0	2.5	2.5	2.5	4	4	6	6	8	8	8	10	10	12	12	12	14	14	16	16	16
130	10.8	2.5	2.5	4	4	6	6	8	8	8	10	10	12	12	14	14	14	16	16	18	18
140	11.7	2.5	2.5	4	4	6	6	8	8	10	10	12	12	14	14	14	16	16	18	18	20
150	12.5	2.5	2.5	4	4	6	6	8	8	10	10	12	12	14	14	14	16	16	18	20	20
160	13.3	2.5	2.5	4	6	6	8	8	10	10	12	12	14	14	16	16	18	20	20	22	22
170	14.2	2.5	2.5	4	6	6	8	8	10	12	12	14	14	16	16	18	20	20	22	22	24
180	15.0	2.5	2.5	4	6	6	8	10	10	12	12	14	16	16	18	18	20	22	22	24	24
190	15.8	2.5	4	4	6	8	8	10	12	12	14	14	16	18	18	20	22	22	24	26	26
200	16.7	2.5	4	4	6	8	8	10	12	12	14	16	16	18	20	20	22	24	24	26	28
220	18.3	2.5	4	6	6	8	10	12	12	14	16	18	18	20	22	22	24	26	28	28	30
240	20.0	2.5	4	6	8	8	10	12	14	16	16	18	20	22	24	24	26	28	30	32	32
260	21.7	2.5	4	6	8	10	12	14	14	16	18	20	22	24	26	26	28	30	32	32	32
280	23.3	2.5	4	6	8	10	12	14	16	18	20	22	24	26	28	28	30	32	32	32	32
300	25.0	2.5	4	6	8	10	12	14	16	18	20	22	24	26	28	30	32	32	32	32	32

**IMPORTANT:** If the appliance to be connected has a motor (refrigerator, freezer, pump, etc.) so starts under load, use the row showing double the watts of the appliance. For example, if a refrigerator requires 60 W, use the 120 W row. Ceiling fans and desk fans do not need larger wire because their motors do not start under load.

This table can be used for panels by entering the total Wp in the watts column, but it is better to use the exact size table.

## 24 V exact size table – for sizing wire to multiple appliances or for connecting solar panels

Appliance load or panel Wp		Distance between battery and appliance (m)														
		1	2	3	4	5	6	7	8	9	10	11	12	13	14	15
Wp or W	A	Exact wire size for a 1 V voltage drop (mm <sup>2</sup> )														
10	0.4	0.02	0.03	0.05	0.07	0.08	0.10	0.12	0.13	0.15	0.17	0.18	0.20	0.22	0.23	0.25
20	0.8	0.03	0.07	0.10	0.13	0.17	0.20	0.23	0.27	0.30	0.33	0.37	0.40	0.43	0.47	0.50
30	1.3	0.05	0.10	0.15	0.20	0.25	0.30	0.35	0.40	0.45	0.50	0.55	0.60	0.65	0.70	0.75
40	1.7	0.07	0.13	0.20	0.27	0.33	0.40	0.47	0.53	0.60	0.67	0.73	0.80	0.87	0.93	1.00
50	2.1	0.08	0.17	0.25	0.33	0.42	0.50	0.58	0.67	0.75	0.83	0.92	1.00	1.08	1.17	1.25
60	2.5	0.10	0.20	0.30	0.40	0.50	0.60	0.70	0.80	0.90	1.00	1.10	1.20	1.30	1.40	1.50
70	2.9	0.12	0.23	0.35	0.47	0.58	0.70	0.82	0.93	1.05	1.17	1.28	1.40	1.52	1.63	1.75
80	3.3	0.13	0.27	0.40	0.53	0.67	0.80	0.93	1.07	1.20	1.33	1.47	1.60	1.73	1.87	2.00
90	3.8	0.15	0.30	0.45	0.60	0.75	0.90	1.05	1.20	1.35	1.50	1.65	1.80	1.95	2.10	2.25
100	4.2	0.17	0.33	0.50	0.67	0.83	1.00	1.17	1.33	1.50	1.67	1.83	2.00	2.17	2.33	2.50
120	5.0	0.20	0.40	0.60	0.80	1.00	1.20	1.40	1.60	1.80	2.00	2.20	2.40	2.60	2.80	3.00
140	5.8	0.23	0.47	0.70	0.93	1.17	1.40	1.63	1.87	2.10	2.33	2.57	2.80	3.03	3.27	3.50
160	6.7	0.27	0.53	0.80	1.07	1.33	1.60	1.87	2.13	2.40	2.67	2.93	3.20	3.47	3.73	4.00
180	7.5	0.30	0.60	0.90	1.20	1.50	1.80	2.10	2.40	2.70	3.00	3.30	3.60	3.90	4.20	4.50
200	8.3	0.33	0.67	1.00	1.33	1.67	2.00	2.33	2.67	3.00	3.33	3.67	4.00	4.33	4.67	5.00
220	9.2	0.37	0.73	1.10	1.47	1.83	2.20	2.57	2.93	3.30	3.67	4.03	4.40	4.77	5.13	5.50
240	10.0	0.40	0.80	1.20	1.60	2.00	2.40	2.80	3.20	3.60	4.00	4.40	4.80	5.20	5.60	6.00
260	10.8	0.43	0.87	1.30	1.73	2.17	2.60	3.03	3.47	3.90	4.33	4.77	5.20	5.63	6.07	6.50
280	11.7	0.47	0.93	1.40	1.87	2.33	2.80	3.27	3.73	4.20	4.67	5.13	5.60	6.07	6.53	7.00
300	12.5	0.50	1.00	1.50	2.00	2.50	3.00	3.50	4.00	4.50	5.00	5.50	6.00	6.50	7.00	7.50
325	13.5	0.54	1.08	1.63	2.17	2.71	3.25	3.79	4.33	4.88	5.42	5.96	6.50	7.04	7.58	8.13
350	14.6	0.58	1.17	1.75	2.33	2.92	3.50	4.08	4.67	5.25	5.83	6.42	7.00	7.58	8.17	8.75
375	15.6	0.63	1.25	1.88	2.50	3.13	3.75	4.38	5.00	5.63	6.25	6.88	7.50	8.13	8.75	9.38
400	16.7	0.67	1.33	2.00	2.67	3.33	4.00	4.67	5.33	6.00	6.67	7.33	8.00	8.67	9.33	10.00
450	18.8	0.75	1.50	2.25	3.00	3.75	4.50	5.25	6.00	6.75	7.50	8.25	9.00	9.75	10.50	11.25
500	20.8	0.83	1.67	2.50	3.33	4.17	5.00	5.83	6.67	7.50	8.33	9.17	10.00	10.83	11.67	12.50
550	22.9	0.92	1.83	2.75	3.67	4.58	5.50	6.42	7.33	8.25	9.17	10.08	11.00	11.92	12.83	13.75
600	25.0	1.00	2.00	3.00	4.00	5.00	6.00	7.00	8.00	9.00	10.00	11.00	12.00	13.00	14.00	15.00
650	27.1	1.08	2.17	3.25	4.33	5.42	6.50	7.58	8.67	9.75	10.83	11.92	13.00	14.08	15.17	16.25
700	29.2	1.17	2.33	3.50	4.67	5.83	7.00	8.17	9.33	10.50	11.67	12.83	14.00	15.17	16.33	17.50
750	31.3	1.25	2.50	3.75	5.00	6.25	7.50	8.75	10.00	11.25	12.50	13.75	15.00	16.25	17.50	18.75
800	33.3	1.33	2.67	4.00	5.33	6.67	8.00	9.33	10.67	12.00	13.33	14.67	16.00	17.33	18.67	20.00
850	35.4	1.42	2.83	4.25	5.67	7.08	8.50	9.92	11.33	12.75	14.17	15.58	17.00	18.42	19.83	21.25
900	37.5	1.50	3.00	4.50	6.00	7.50	9.00	10.50	12.00	13.50	15.00	16.50	18.00	19.50	21.00	22.50
950	39.6	1.58	3.17	4.75	6.33	7.92	9.50	11.08	12.67	14.25	15.83	17.42	19.00	20.58	22.17	23.75
1000	41.7	1.67	3.33	5.00	6.67	8.33	10.00	11.67	13.33	15.00	16.67	18.33	20.00	21.67	23.33	25.00
1100	45.8	1.83	3.67	5.50	7.33	9.17	11.00	12.83	14.67	16.50	18.33	20.17	22.00	23.83	25.67	27.50
1200	50.0	2.00	4.00	6.00	8.00	10.00	12.00	14.00	16.00	18.00	20.00	22.00	24.00	26.00	28.00	30.00
1300	54.2	2.17	4.33	6.50	8.67	10.83	13.00	15.17	17.33	19.50	21.67	23.83	26.00	28.17	30.33	32.50
1400	58.3	2.33	4.67	7.00	9.33	11.67	14.00	16.33	18.67	21.00	23.33	25.67	28.00	30.33	32.67	35.00
1500	62.5	2.50	5.00	7.50	10.00	12.50	15.00	17.50	20.00	22.50	25.00	27.50	30.00	32.50	35.00	37.50

**For connecting panels:** Enter the table using the total Wp panel capacity as watt load. For example, for a single panel with 75 Wp capacity, go to the row for 75 W. If the exact capacity is not shown, use the next larger row (80 W). For a 250 Wp set of panels, use the row for 260 W, and so on.

**IMPORTANT:** If the appliance to be connected has a motor (refrigerator, freezer, pump, etc.) so starts under load, the wire size given in the table should be doubled. The motors of fans do not start under load so a larger wire is not needed. This table is for circuits with several appliances on one wire. To find the wire size to each appliance follow these steps:

- 1) Find the watts required by each appliance and the distance along the wire path from the battery to each appliance.
- 2) Use the table to find the minimum wire size for each appliance.
- 3) The wire from the battery to the first appliance must be no smaller than the sum of the wire sizes to all the appliances.
- 4) The wire from the first appliance to the second must be no smaller than the sum of the wire sizes to the second and later appliances.
- 5) The wire from the second appliance to the third must be no smaller than the sum of the wire sizes to the third and later appliances.



## 24 V wire sizing table – standard wire (metric)

Load		Distance between battery and load (m)																				
		1	2	3	4	5	6	7	8	9	10	11	12	13	14	15	16	17	18	19	20	
W	A	Standard size wire needed (mm <sup>2</sup> )																				
Under	Under																					
100	4.2	2.5	2.5	2.5	2.5	2.5	2.5	2.5	2.5	2.5	2.5	2.5	2.5	2.5	2.5	2.5	2.5	3.5	4.5	5.5	6.5	7.5
100	4.2	2.5	2.5	2.5	2.5	2.5	2.5	2.5	2.5	2.5	2.5	2.5	2.5	2.5	2.5	2.5	2.5	4	4	4	4	4
110	4.6	2.5	2.5	2.5	2.5	2.5	2.5	2.5	2.5	2.5	2.5	2.5	2.5	2.5	2.5	2.5	4	4	4	4	4	4
120	5.0	2.5	2.5	2.5	2.5	2.5	2.5	2.5	2.5	2.5	2.5	2.5	2.5	2.5	2.5	4	4	4	4	4	4	4
130	5.4	2.5	2.5	2.5	2.5	2.5	2.5	2.5	2.5	2.5	2.5	2.5	2.5	2.5	4	4	4	4	4	4	4	6
140	5.8	2.5	2.5	2.5	2.5	2.5	2.5	2.5	2.5	2.5	2.5	2.5	2.5	4	4	4	4	4	4	4	6	6
150	6.3	2.5	2.5	2.5	2.5	2.5	2.5	2.5	2.5	2.5	2.5	2.5	4	4	4	4	4	4	6	6	6	6
160	6.7	2.5	2.5	2.5	2.5	2.5	2.5	2.5	2.5	2.5	2.5	4	4	4	4	4	4	6	6	6	6	6
170	7.1	2.5	2.5	2.5	2.5	2.5	2.5	2.5	2.5	2.5	4	4	4	4	4	4	6	6	6	6	6	6
180	7.5	2.5	2.5	2.5	2.5	2.5	2.5	2.5	2.5	2.5	4	4	4	4	4	6	6	6	6	6	6	6
190	7.9	2.5	2.5	2.5	2.5	2.5	2.5	2.5	2.5	4	4	4	4	4	6	6	6	6	6	6	8	8
200	8.3	2.5	2.5	2.5	2.5	2.5	2.5	2.5	2.5	4	4	4	4	4	6	6	6	6	6	6	8	8
220	9.2	2.5	2.5	2.5	2.5	2.5	2.5	2.5	4	4	4	4	6	6	6	6	6	8	8	8	8	8
240	10.0	2.5	2.5	2.5	2.5	2.5	2.5	4	4	4	4	6	6	6	6	6	8	8	8	8	8	8
260	10.8	2.5	2.5	2.5	2.5	2.5	4	4	4	4	6	6	6	6	8	8	8	8	8	8	10	10
280	11.7	2.5	2.5	2.5	2.5	2.5	4	4	4	6	6	6	6	8	8	8	8	8	8	10	10	10
300	12.5	2.5	2.5	2.5	2.5	2.5	4	4	4	6	6	6	6	8	8	8	8	8	10	10	10	10
350	14.6	2.5	2.5	2.5	2.5	4	4	6	6	6	6	8	8	8	10	10	10	10	10	12	12	12
400	16.7	2.5	2.5	2.5	4	4	4	6	6	6	8	8	8	10	10	10	12	12	12	14	14	14
450	18.8	2.5	2.5	2.5	4	4	6	6	6	8	8	10	10	10	12	12	12	14	14	16	16	16
500	20.8	2.5	2.5	2.5	4	6	6	6	8	8	10	10	10	12	12	14	14	16	16	16	18	18
550	22.9	2.5	2.5	4	4	6	6	8	8	10	10	12	12	12	14	14	16	16	18	18	20	20
600	25.0	2.5	2.5	4	4	6	6	8	8	10	10	12	12	14	14	16	16	18	18	20	20	20
650	27.1	2.5	2.5	4	6	6	8	8	10	10	12	12	14	16	16	18	18	20	20	22	22	22
700	29.2	2.5	2.5	4	6	6	8	10	10	12	12	14	14	16	18	18	20	20	22	24	24	24
750	31.3	2.5	2.5	4	6	8	8	10	10	12	14	14	16	18	18	20	20	22	24	24	26	26
800	33.3	2.5	4	4	6	8	8	10	12	12	14	16	16	18	20	20	22	24	24	26	28	28
850	35.4	2.5	4	6	6	8	10	10	12	14	16	16	18	20	20	22	24	26	26	28	30	30
900	37.5	2.5	4	6	6	8	10	12	12	14	16	18	18	20	22	24	24	26	28	30	30	30
950	39.6	2.5	4	6	8	8	10	12	14	16	16	18	20	22	24	24	26	28	30	32	32	32
1000	41.7	2.5	4	6	8	10	10	12	14	16	18	20	20	22	24	26	28	30	30	32	32	32

**IMPORTANT:** If the appliance to be connected has a motor (refrigerator, freezer, pump, etc.) so starts under load, use the row showing double the watts of the appliance. For example, if a refrigerator requires 60 W, use the 120 W row. Ceiling fans and desk fans do not need larger wire because their motors do not start under load.

This table can be used for panels by entering the total Wp in the watts column, but it is better to use the exact size table.

# Appliances

## INTRODUCTION

The reason for installing a solar PV system is to be able to use electrical appliances. Appliances such as electric lights, refrigerators, video players, stereos, radios, pumps and power tools can all be connected to PV systems.

When a PV system is first designed, the size of the system is carefully matched with the appliances to be used. If you want to increase the size or number of appliances connected to the system, larger solar panels and batteries must be installed. If a new appliance is attached to an existing PV system without increasing the size of the panels and batteries, the battery life will be shortened and the system will probably not work well. Remember that in a house with a PV system designed to operate two lights, adding just one more light can cause a 50% increase in electrical use and will probably mean adding another panel and a larger battery if the system is to work well.

The solar panels that produce electrical power and the batteries that store the power are expensive. So appliances that are connected to PV systems should use as little energy as possible. Cheap appliances usually use a lot more energy than the special, power-saving appliances made for use with PV systems. So buying cheap appliances may mean that you need an expensive PV system because the appliances use a lot of power. It is usually best to buy more expensive, high-quality, high-efficiency appliances so that the PV system can be kept as small and low in cost as possible.



Many different appliances can be powered by a solar system but when new appliances are added make sure that the panel and battery are increased in size so that enough power is available.

Appliances often used with small solar systems include:

- fluorescent lights
- black and white televisions
- radios and stereos
- table fans
- ceiling fans

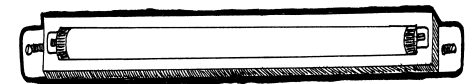

Energy-efficient fluorescent lights are readily available for use with solar power.

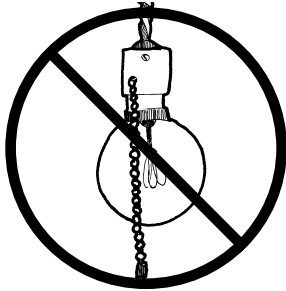

Incandescent lights use over twice the electricity as fluorescent lights and do not last as long. Never use incandescent lights with solar power.

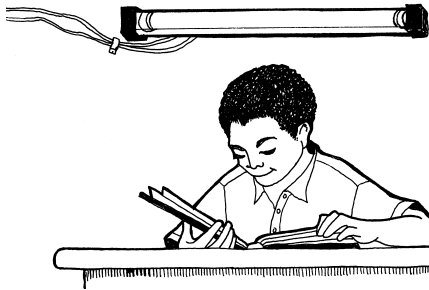

Always use the type of light that is best for your purpose. Place lights where they are most needed.



## ELECTRIC LIGHTS

The most common appliance is the electric light. There are two main types of electric light: incandescent and fluorescent. Incandescent lights work by passing enough electricity through a thin wire to make it so hot that it glows brightly. They waste a lot of electricity but they are simple and cheap. Fluorescent lights work in a more complicated way but can provide over twice as much light as an incandescent light for the same amount of electricity.

When you install lights, remember to place them where the light is most needed, not just anywhere that seems convenient. If there is just one light in a room, the best place is usually the centre of the ceiling. In general, if the electric light is to replace a kerosene wick lamp (hurricane lamp) or pressure lamp, place the new electric light near where the old lamp was, as that must be where people needed light.

Always keep the connecting wire as short as possible. Fasten the connecting wire to the wall or ceiling about every metre. Always fasten the light fixture to the wall or ceiling or use special hangers, never hang it from the electrical wire unless it is designed to use the wire as a support.

Never replace a faulty fluorescent light with a 12 V incandescent light from a vehicle. To get the same amount of light from an incandescent light, the PV system must provide twice as much power as was needed with the old fluorescent light. Unless more solar panels and a larger battery are installed to provide this extra power, replacing fluorescent lights with incandescent lights will cause the battery to fail quickly.

Fluorescent lights made for use with PV systems work on dc electricity at the same voltage as the battery. If the system has a 24 V battery, the lights must also be designed for 24 V dc. Because dc electricity has a positive and a negative terminal, the positive terminal of the light must always be connected to the wire that goes to

the positive terminal of the battery and the negative terminal of the light to the negative terminal of the battery. If wrongly connected, the light usually will not work and may be damaged.

Also some types of fluorescent light may be damaged if the electricity is turned on without a bulb in the appliance. Make sure that a fluorescent bulb is fitted before turning on the electricity.

Although special dc light fixtures must be used, ordinary electrical switches like those used in city houses can be used to turn the light on and off if they are of good quality. The type of switch that snaps the contacts together, called a toggle switch, will last longer and give better service than cheap switches that just slide the contacts together.

## REFRIGERATORS

You can use a small, high-quality refrigerator intended for ac operation by installing a high-quality sine-wave inverter to convert the solar dc power to mains ac power. You must not use a modified sine-wave or square-wave inverter because they will cause the motor to overheat. Sine-wave inverters are expensive. Usually, installing a special refrigerator designed for solar use will be cheaper. Then you will not need the expensive inverter. Also, the amount of electricity the solar refrigerator uses will be much lower than the amount of electricity to run a regular refrigerator. Therefore, a smaller size of solar panel and battery can be used with the refrigerator made for solar power.

Because solar-powered refrigerators are often used for remote health centres, their installation, use and maintenance is discussed fully in Chapter 8.

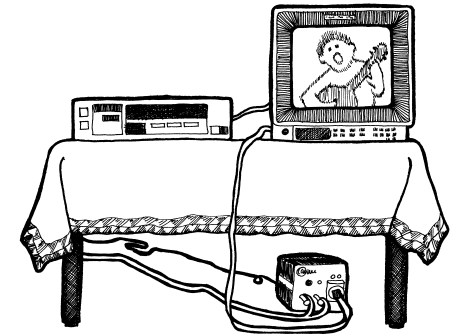

Although it is possible to buy many kinds of appliance that operate from 12 V dc, they may be hard to find and expensive. By using an inverter, the dc power can be converted to ac. Then regular household appliances can be used. The disadvantage is that the inverter uses more energy than dc appliances so the panel and battery may need to be larger.

There are different kinds of inverters, so make sure that the type you buy will operate the appliances you want to use without damaging them. If the inverter must power an appliance with a motor, such as a pump or a washing machine, a special high-quality inverter should be used or the motor may be damaged. Do not get an inverter larger than you need. It will waste energy and cost more than is necessary.

Always keep the wiring short between the battery and the inverter. The wiring from the inverter to the appliances can be longer as it is at a higher voltage.

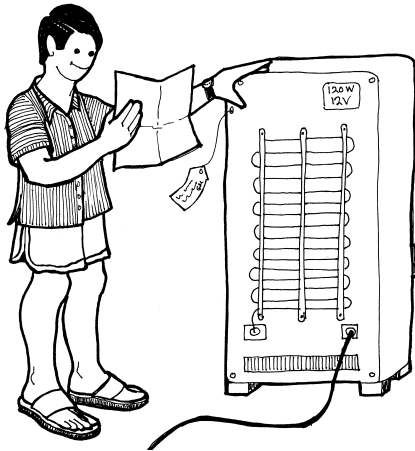

A solar refrigerator may use as much electricity as 12 lights kept on for 4 hours a day. A conventional refrigerator and an inverter may use as much as 20 lights.

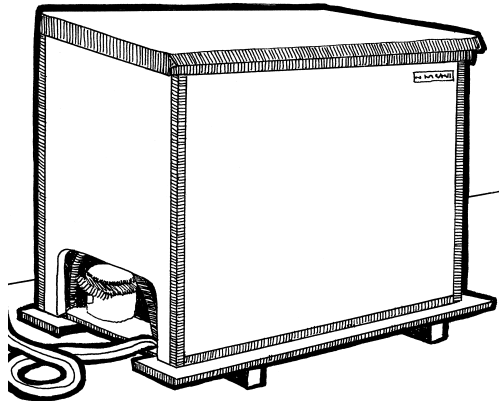

A freezer may use twice as much electricity as a refrigerator.

A refrigerator can use more electricity than 12 lights used 4 hours a day. If a refrigerator is added to a PV system that has already been installed, make sure that there are enough panels and batteries to handle the new, large load. Make sure that the discharge controller will work properly with the refrigerator.

## FREEZERS

Refrigerators are usually adjusted so that they never get cold enough inside to freeze water or food. When they are designed for temperatures that are cold enough to freeze water, they are called freezers. Although many refrigerators will get cold enough to freeze food, they are not designed to operate at such a low temperature and will use much more electricity than a freezer. With a PV system, you should only use a freezer for freezing food, not a refrigerator turned to its coldest setting. As electricity is used to make the inside of a refrigerator cold, setting a refrigerator for colder operation uses more electricity. A freezer is very cold inside and therefore requires a great deal of electricity. To freeze water or food will require many more solar panels and much larger battery capacity than just to cool things without freezing them. A freezer used regularly to freeze food or water may need twice as many panels and double the battery capacity as a refrigerator that does not freeze.

Refrigerators and freezers should be installed in a cool room out of the sun. Remember that the refrigerator gives off heat, so the room should be well ventilated.

## VIDEOS AND TELEVISIONS

Although it is possible to buy a video player and a television set that will operate directly from a PV system battery, they are not always easy to find. Most videos and televisions must have a power converter installed to change the low-voltage dc of the PV system to the higher ac voltage that they need to work. This converter, usually called an inverter, is expensive and requires extra energy in addition to the energy used by the appliance. Inverters should be matched in size to the appliance for the most efficient use of solar energy and should be turned off with the appliance.

The inverter *input* is dc so the positive and negative terminals must be connected correctly. The inverter *output* is ac so has no positive and negative terminals.

Videos and televisions should be installed in a cool, clean place. When not in use they may be covered with a cloth or plastic for protection from dust and water, but when in use the covers should be completely removed to allow air to flow freely and cool the appliances.

A small black and white television uses little more electricity than a light. A colour television uses five or six times as much electricity as a black and white one, so more solar panels and a larger battery may be needed for it to work properly.

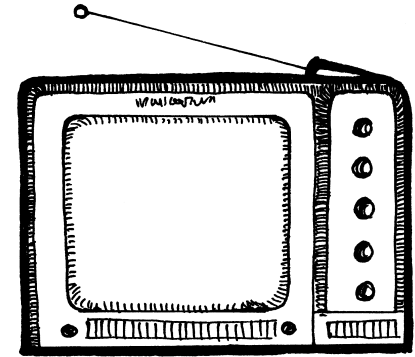

A small black and white television may use no more electricity than one light. A colour television of the same size, which would need an inverter to make ac, may use as much energy as seven lights.

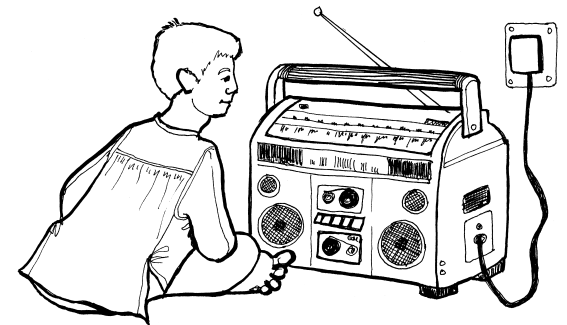

A small portable radio or stereo may use less energy than one light. A large machine with the volume turned up high may use as much energy as three lights.



Washing machines made for solar power are hard to find. Using an inverter for a conventional ac washing machine is expensive because it must be of high quality to run the motor.

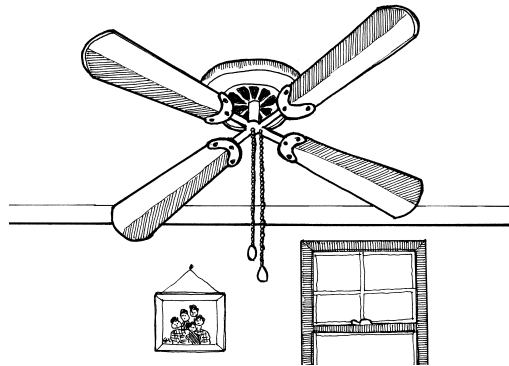

Ceiling fans made especially for solar power are readily available and may use no more energy than a light.

## RADIO AND STEREO EQUIPMENT

Radios and stereos may not work directly from the solar power supply. They often need 6 V or 9 V to operate. A dc/dc converter is needed to change the voltage. If the appliance is normally plugged into a mains power wall outlet and cannot operate on batteries, then an ac inverter is needed. If the appliance is normally battery-operated and has a small socket for a dc power supply, then a dc/dc converter is usually needed.

Portable radios and stereos usually need less power than a light. Larger stereos that are not portable may use more energy than two or three lights, so more solar panels may be needed. Also, the louder the radio or stereo is played, the more electricity it uses.

## OTHER APPLIANCES

Electric drills, fans and small pumps can be powered by a PV system, though expensive power converters will sometimes be needed.

Special electric irons are available for use with PV systems but they use a lot of energy so larger panels and a larger battery may be needed if the iron will be used often.

Any electrical appliance can be operated from a PV system if the system is large enough to provide sufficient electricity. Because solar panels and batteries are expensive, appliances that use a lot of energy, such as air conditioners, steam irons and electric cooking appliances, are not commonly used.

## SUMMARY

---

In choosing appliances for use with a PV system, it is always best to choose those designed for solar power. The appliance voltage requirements must match the voltage of the battery unless a power converter is also installed. Appliances must not be added to a PV system without increasing the number of solar panels and the size of the battery to supply the increased amount of electricity needed.

### BUSINESS MACHINES

A portable computer is the best choice for use with solar power. It is very energy-efficient and can easily be adapted to work from a 12 V battery. A desktop computer is often cheaper but it may require five times as much electricity to operate as a portable computer. The cost of the extra panel and battery capacity to run the desktop computer will be much more than the extra cost of a portable computer. If a desktop computer must be used, always use a flat-screen LCD (liquid crystal display) monitor because it uses much less energy than other types.

Some models of ink-jet printers can be used with 12 V dc. Ink-jet printers use little energy, not much more than one light. Laser printers use a lot of energy and are not a good choice for use with solar power. Some types of copy machine are very energy-efficient, others are not. Make sure that you use only energy-efficient copy machines with solar power.

Small fax machines use little energy but rarely work with 12 V power, so a small inverter needs to be installed.



# Photovoltaic-powered refrigerators

## INTRODUCTION

Although solar-powered refrigerators are rare in homes, they are often found in rural health centres. Many important vaccines and medicines must be stored at carefully controlled, low temperatures. Solar refrigerators are expensive but provide the only way that vaccines and medicines can be stored at many remote sites.

## REFRIGERATION PRINCIPLES

When you pump a bicycle tyre with a hand pump, the body of the pump feels warm after a while. Air in the pump is compressed by the piston, heats up and transfers its heat to the body of the pump. Any process of compression creates heat.

The opposite of compression is expansion. If you let air out of a tyre, the air feels quite cool. The air was compressed while in the tyre then, when you let the air out, it expands and cools.

When you wet a rag, the rag cools as the water evaporates to the air. One way to cool yourself in the tropics is to wet your head and let the water evaporate to remove some of the heat. As evaporation occurs, heat is removed from the liquid that is evaporating and it cools.

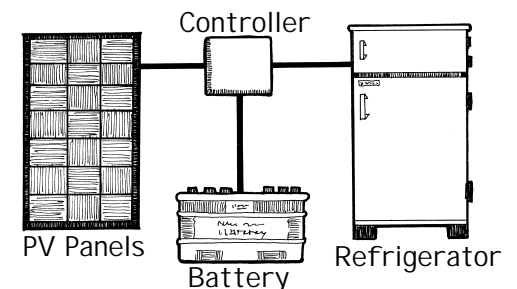

A system for solar refrigeration uses solar panels, a controller, a battery and a 12 V or 24 V dc refrigerator.

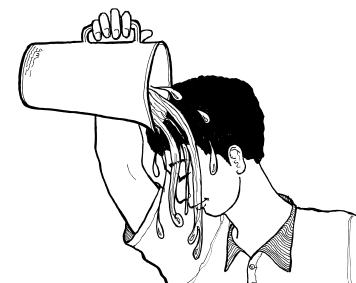

One way to cool yourself is to wet your head. The evaporation of the water has a cooling effect.

Three types of solar photovoltaic refrigerators are available today.

The most widely used and generally the most satisfactory is the compressor refrigerator. In this type, a refrigerant is circulated and, through mechanical compression and heat transfer, alternates between being a liquid and being a gas. A second common type is the absorption refrigerator.

In this type, the two materials in the refrigeration circuit get cold when they are mixed together. Kerosene and liquefied petroleum gas (LPG) refrigerators use this system as they require a high temperature to operate. Electricity can be used but absorption refrigerators use much more electrical energy than compression refrigerators.

The third type is the thermoelectric refrigerator. It uses a solid-state device, similar to a solar cell or a transistor, with two poles. One pole is cooled and one pole is heated when an electric current is passed through the device. This type of refrigerator can be made very small and is the best choice where less than a litre of refrigeration capacity is needed. The larger sizes usually needed for vaccine storage or domestic use are very expensive and use considerably more energy than the compressor type.

So we can absorb heat and make something feel cool by evaporating a liquid or expanding a gas.

When you use any kind of spray can, such as insect killer, you may have noticed that the spray and the tip of the can become cold. What happens is that the high-pressure liquid in the can both expands and evaporates as you press on the cap. The pressure of the liquid drops as it goes through the tiny hole in the cap and the liquid evaporates into the surrounding air. This combination of evaporation and expansion removes heat from the air, making it feel cold.

## COMPRESSION REFRIGERATION

---

When a refrigerator runs, the cooling unit absorbs heat from the inside of the refrigerator box then moves the heat to the air outside the box. This warms the air in the room and cools the inside of the refrigerator. So for the inside of the refrigerator to be cool, something on the outside must be hot.

Inside a refrigerator, a special liquid is sprayed from a small pipe into a larger pipe. This makes the liquid evaporate and expand. As it evaporates and expands, the large pipe becomes cold and a large amount of heat is drawn from the surrounding air. This cools the inside of the box. The low-pressure gas is then pulled from the large pipe and raised in pressure by a compressor. Raising the pressure heats the gas. The high-pressure, hot gas goes through a pipe to the condenser located outside the refrigerator box. The air in the room can then cool the gas. This turns the gas back into a liquid, a process called condensing. The pressure from the compressor

sends the liquid back into the refrigerator box to evaporate and expand again and repeat the cycle. This circulating material is called the refrigerant.

So a refrigerator works by circulating the refrigerant through an evaporator, a compressor, a condenser and an expansion valve in a closed cycle. This closed system has two pressure zones, a high-pressure zone in the condenser and a low-pressure zone in the evaporator. The pressure difference is maintained by the compressor and a device that stops the liquid from flowing too fast, either a tiny tube called a capillary tube or a more complex device called an expansion valve. The diagram shows the basic components of a refrigeration system and the two pressure zones.

## EVAPORATOR

The evaporator is located in the cold compartment of the refrigerator. The evaporator is usually made from aluminium and is usually visible in the cold compartment though sometimes it is moulded inside the plastic walls of the refrigerator compartment so that you cannot see it. The evaporator is where the high-pressure liquid refrigerant expands and evaporates causing it to absorb heat from the air in the refrigerator. When the refrigerant evaporates it becomes a low-pressure gas. In the process, the evaporator becomes very cold. The vaporized refrigerant leaves the evaporator as a cold, low-pressure gas and is then sucked into the compressor.

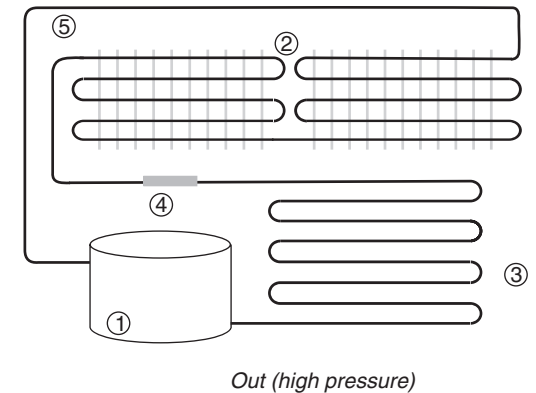

- ① Sealed compressor/motor unit
- ② Evaporator (inside cold space - cold)
- ③ Condenser (outside cold space - hot)
- ④ Filter and dryer
- ⑤ Capillary tube (or expansion valve)

Block diagram of a compressor-type refrigerator.

In a compressor refrigerator, cooling is done in three ways:

- 1) by expansion of the refrigerant at the capillary tube outlet
- 2) by evaporation of the refrigerant in the evaporator
- 3) by direct cooling of the refrigerant in the condenser.

Heat moves from inside the refrigerator into the refrigerant at the evaporator. It is then forced into the condenser by the compressor. At the condenser, the heat absorbed in the refrigerant passes to the outside air. Least electricity is used when heat moves easily into the evaporator and out of the condenser.

If there is ice on the evaporator or dirt on the condenser, the heat will move more slowly and the refrigerator will need more energy for cooling.

If the compressor is dirty, it will get hot and that heat will pass into the refrigerant, forcing the condenser to lose more heat than normal. More energy will be needed as a result.

Therefore it is important to keep the refrigerator clean and to defrost it whenever more than a few millimetres of ice have formed on the evaporator.

## COMPRESSOR

---

The compressor is usually located in the base behind the refrigerator cabinet and is sealed inside a black metal shell. An electric motor also sealed inside the metal shell drives the compressor, and the two together are called the compressor unit. Its function is to suck in the cold, low-pressure gas from the evaporator and increase its pressure. It also raises the temperature of the gas. The compressor then forces the hot, high-pressure gas into the condenser. Most refrigerators in the city use an ac motor to drive the compressor. A photovoltaic-powered refrigerator usually has a special dc motor to drive the compressor.

## CONDENSER

---

The condenser is usually located on the back of the refrigerator and is always hot when the compressor is operating. It acts like the radiator used to cool a car engine. The heat absorbed from inside the refrigerator by the refrigerant in the evaporator is compressed and passed through the condenser so that the heat can be carried away by the surrounding air. As the hot, high-pressure refrigerant cools, it condenses into a liquid. The condenser must cool the hot gas as much as possible for the inside of the refrigerator to remain as cool as possible. Any heat that cannot leave at the condenser is sent back into the refrigerator and the refrigerator does not work well. Because of the large amount of heat that must be lost from the condenser, the condenser must be clean and cool air must be able to flow over the hot condenser pipes.

## EXPANSION VALVE

---

The refrigeration cycle is complete when this cooled, high-pressure liquid expands into the evaporator through a flow-restricting device, the capillary tube or expansion valve. The purpose of the flow restrictor is to allow a high pressure to exist on the compressor side and a low pressure on the evaporator side of the refrigeration circuit. Most small refrigerators use a very small diameter copper capillary tube for restricting the flow of refrigerant. The diameter of this tube is much smaller than the condenser tubing, restricting the flow and causing a large pressure drop in the liquid refrigerant from the condenser. Without this flow restriction, the hot refrigerant in the condenser would not have time to lose its heat before flowing back into the refrigerator.

## ACCESSORIES

---

Although the basic system described above will work, for long life and best operation other components are included. At the outlet of the condenser, a device called a strainer-drier traps scale, dirt and moisture to prevent blocking of the flow restrictor. All refrigerators also have a thermostat that controls the on/off operation of the compressor unit by measuring the inside temperature of the refrigerator and turning the compressor on when the cold compartment gets too warm or off when it gets too cold.

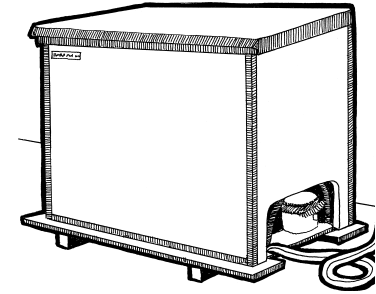

A typical vaccine refrigerator with top-opening lid, external batteries and the compressor and condenser in the main housing.

The energy to keep a vaccine refrigerator cool is needed mainly to remove outside heat that leaks into the cold compartment. The cabinet is therefore a very important component of a refrigerator. It has to be well insulated, solidly constructed and resistant to corrosion. The door must fit tightly. The door hinges and latches should be well made and hold the door firmly in place without leaking, even when the seals are old.

The energy needed to keep a refrigerator cool is determined by the difference in temperature between the inside of the refrigerator, whatever is placed in the refrigerator for cooling, and the outside air.

A typical, good-quality solar PV vaccine refrigerator will use around 275 Wh/day of energy when the inside is 8 °C and the outside 30 °C and the door kept closed.

Opening the door of a refrigerator allows warm air to enter the cold compartment. About 1 Wh will be needed to cool that air to 8 °C.

Placing 1 litre of water or vaccine in the refrigerator requires about 45 Wh to cool it from 30 °C to 8 °C.

Freezing 1 litre of 30 °C water takes as much as 200 Wh of energy.

Thus in a refrigerator that is opened five times per day, freezes 2 litres of water per day and cools ½ litre of vaccine per day, the total energy use will be about:

Base load = 275 Wh/day

Door openings =  $5 \times 1 = 5$  Wh/day

Freezing water for ice packs  
=  $200 \times 2 = 400$  Wh/day

Cooling ½ litre of vaccine  
=  $45 \times \frac{1}{2} = 22.5$  Wh/day

So the total energy use will be about:

$275 + 5 + 400 + 22.5 = 702.5$  Wh/day

## PHOTOVOLTAIC-POWERED COMPRESSION REFRIGERATORS

---

### ■ Cabinet

---

All the solar refrigerator components are housed in a cabinet that is a closed insulated box. The cabinet may be vertical with the door on the front or horizontal with the door on the top. These cabinets are very well insulated and their doors have tight seals to prevent cold air from escaping from the cold compartment. Photovoltaic refrigerators need to be very well insulated because of the high cost of producing electricity from solar panels. High-quality insulation is used to reduce heat flow from the warm air outside to the cool air inside the cabinet. Polyurethane foam is commonly used as insulation and its thickness varies from 5 cm to 12 cm for refrigerators and up to 15 cm for freezers. Door seals are carefully designed and installed to reduce cold air leaks around the door. Double rows and sometimes triple rows of door gaskets are often used on photovoltaic-powered refrigerators to reduce leakage to a minimum.

As cold air is heavier than warm air, every time you open the front door of a vertical refrigerator, cold air pours out of the interior. With a top-opening chest-type refrigerator, the heavy cold air stays in the cold compartment and less cold air is lost. Most photovoltaic refrigerators have a top-opening door because these are the most efficient. Readily available solar refrigerators have a capacity from less than 50 litres to over 300 litres. The cabinet is often divided into a main refrigerator compartment and a freezer box for making ice. Some small refrigerators do not include a freezer compartment.

## ■ Compressor unit

A photovoltaic refrigerator is identical to a regular ac refrigerator except that it is powered by dc electricity and is usually better insulated. The refrigerator is connected to the PV system just like any other appliance. Most solar refrigerators use a Danfoss brand compressor unit that has proved to be highly reliable through wide use in marine, vehicle and PV applications.

Usually, dc motors have a mechanical switching unit called a commutator. The commutator receives the electrical power for the motor through two or more carbon brushes. While this is low in cost and reliable, the brushes wear out and have to be replaced regularly. As the compressor motor is sealed inside a metal case, brushes cannot be used because they cannot be replaced when they wear out. In the Danfoss dc compressor unit, the commutation is done by an electronic control unit that senses the rotation of the motor and reverses the dc current at precisely the right time to keep the motor turning just like a mechanical commutator and brushes in a conventional dc motor.

Sometimes the Danfoss control unit is called an inverter because it converts dc into a form of ac. Though technically it is a type of inverter, it cannot be used to power anything but the particular model of Danfoss compressor it is built for. A Danfoss compressor cannot be powered from any other type of inverter.

Danfoss compressor units are available for either 12 V or 24 V operation and are usually supplied with an electronic commutator unit that also acts like a discharge controller. The electronic unit turns off the power to the compressor if the input voltage falls below about 10.5 V and turns it back on as soon as the voltage reaches 11.5 V. If the voltage falls too low, the compressor will try to start four times with 20 seconds between attempts. If the voltage stays too low and the motor cannot start, the control will turn off the power to the motor until the voltage rises to about 11.5 V. It also protects the motor from overheating. Overheating can be caused by too frequent starting or operating in a very hot room. Usually a fuse is also fitted to protect against damage from polarity reversal during installation.

### Exercise 1

The manufacturer states that a refrigerator takes 325 Wh/day to cool to 8 °C when the outside air is 32 °C. It will be used to make two ½ litre ice packs per day and about 1 litre of water and vaccines will be cooled each day. It will be opened about six times a day. About how many watt-hours per day will the battery need to supply to operate the refrigerator?

Base load = 325 Wh/day

Ice-pack load =  $1 \times 200 = 200$  Wh/day

Cooling load =  $1 \times 45 = 45$  Wh/day

Opening load =  $6 \times 1 = 6$  Wh/day

Total load =  $325 + 200 + 45 + 6 = 576$  Wh/day

### Exercise 2

The rated base load for a refrigerator is given as 290 Wh/day at 30 °C. It will be used to freeze five ½ litre ice packs each week. Every day it will be opened an average of ten times and about ½ litre of vaccines added every day for cooling. What is the estimated total daily watt-hour load?

Base load = 290 Wh/day

Freezing load =  $5 \times \frac{1}{2} \times 200 = 500$  Wh/week  
 $= 500 \div 7$  Wh/day  
 $= 71.4$  Wh/day

Cooling load =  $45 \times \frac{1}{2} = 22.5$  Wh/day

Opening load =  $10 \times 1 = 10$  Wh/day

Total load =  $290 + 71.4 + 22.5 + 10 = 393.9$  Wh/day

The duty cycle of a refrigerator compressor is the percentage of time it must run to keep the correct temperature in the refrigerator. The greater the cooling load, the longer the compressor must run and the higher the duty cycle.

To calculate the duty cycle, estimate the total watt-hours per day then divide by the number of watts the compressor needs to run. This gives the number of hours per day the compressor actually runs. Then divide the number of hours by 24 (hours in a day). The result is the fraction of a day that the compressor must run. Multiply by 100 to get the percentage of the day the compressor must run. This is the duty cycle.

### Exercise 1

A refrigerator compressor takes 50 W to operate. The total daily energy it needs to operate is estimated at 700 Wh/day. What is the duty cycle of the compressor expected to be?

1. Divide total watt-hours per day by compressor watts:

$$700 \text{ Wh/day} \div 50 \text{ W} = 14 \text{ hours per day}$$

2. Divide result by 24:

$$14 \div 24 = 0.58$$

3. Multiply result by 100 to give percentage:

$$0.58 \times 100 = 58\%$$

Some refrigerators use membrane-type compressors as in a diaphragm pump. These units are cheaper than rotary compressors and work well in very small refrigerators, but they are not very efficient and require more solar panels to operate than the same size refrigerator with a rotary compressor.

## DUTY CYCLE

---

A thermostat is just an electrical switch connected to the power control unit. It has a temperature probe inserted into the cold compartment. The thermostat controls the on/off operation of the compressor unit. As long as power is supplied to the control unit, the compressor switches on when the thermostat senses an inside temperature that is too high. When the required temperature is reached, the thermostat switches off the compressor unit. This on/off cycle will repeat as long as the refrigerator is powered. The percentage of time the compressor unit is running is called the duty cycle. For example, a refrigerator with a 60% duty cycle runs the compressor 60% of the time and it is off the remaining 40%. The duty cycle depends on how the refrigerator is used, its condition and its design. A 50% duty cycle is typical for a refrigerator operating normally.

Duty cycle is increased (the compressor runs a larger percentage of the time) when warm items are added to the refrigerator for cooling. Lowering the thermostat setting to get a colder temperature also increases the duty cycle.

If the evaporator is covered with thick frost, the heat cannot easily pass from the air in the refrigerator to the refrigerant inside the evaporator and the compressor



must run longer. The frost reduces the efficiency of the evaporator and increases the compressor duty cycle, which uses more energy. Therefore it is important for the efficient operation of the refrigerator to defrost the evaporator regularly.

The same thing happens on the condenser side of the refrigeration circuit. If the condenser is dirty, the heat lost through the condenser is reduced and the thermostat will call for more cooling power, which increases the duty cycle.

The duty cycle also increases when the door is frequently opened, because warm air enters the refrigerator each time and the compressor must run longer in order to cool that air. The more you open the door, the longer the compressor will operate before switching off and the more electrical energy will be needed.

As the room temperature increases, more heat leaks into the refrigerator and it is more difficult to remove heat from the condenser. Therefore, the duty cycle increases rapidly as room temperature rises.

Every time the duty cycle is increased, more electricity is used by the compressor. A Danfoss compressor unit uses about 50 W of energy when running and tests have shown that the typical energy consumption for a solar refrigerator is about 300 Wh/day if the door is not opened and there is no load on the cooling unit. The energy consumption increases as the load increases. When ice is being made, it may go up to 600 or 700 Wh/day. This means that at least 250 Wp of solar panels are needed to operate a refrigerator reliably in most tropical climates. Typical vaccine refrigerator systems for rural health centres need 250 to 350 Wp of panel capacity.

PV refrigerator troubleshooting

**Problem:** unit is too cold.

Probable causes:

thermostat incorrectly set or faulty.

**Problem:** unit runs continually but does not stay cold enough.

Probable causes:

(1) low level of refrigerant; (2) badly leaking door seal.

**Problem:** unit does not run continually and does not stay cold enough.

Probable causes:

(1) thermostat incorrectly set or faulty;  
(2) battery often runs down because not enough energy from the panels or too much energy used by the refrigerator.

**Problem:** Battery regularly runs down to the point where compressor will not start.

Probable causes:

(1) too much shade on the solar panels;  
(2) panels too small; (3) wiring problems at the panels so not all of them provide power;  
(4) poor connections somewhere between the panels and the refrigerator; (5) controller set points incorrect or controller faulty;  
(6) user trying to cool too many things, or otherwise not using refrigerator properly;  
(7) battery not functioning correctly.

**Problem:** Compressor does not run at all.

Probable causes:

(1) wiring or connection problem between battery and refrigerator; (2) faulty compressor or compressor controller;  
(3) faulty thermostat.

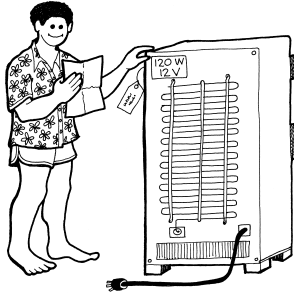

Every model of refrigerator is slightly different. Always carefully follow the manufacturer's installation and maintenance instructions to get the best service from the unit.

#### PV refrigerator maintenance

The most important maintenance job is to clean all parts of the refrigerator inside and out. Especially: (1) condenser; (2) evaporator (defrost and wipe clean); (3) door seals; (4) compressor and compressor controller.

Temperature and connections need to be checked. Also do all the regular PV system maintenance checks (see Chapter 10).

## MAINTENANCE

The maintenance of solar-powered refrigerators is the same as for standard ac units. They must be kept clean to operate efficiently and the door seals must be kept in good condition.

Cleaning the condenser is important because a layer of dirt will act as an insulator and reduce the efficiency of the appliance. The compressor and electronic control unit should also be kept clean.

A poorly sealing door is a common reason for high electricity consumption in a refrigerator. The seals have to be replaced if damaged and the hinges must not be loose or wrongly adjusted. When the door is shut, there should be no way for warm air to enter the refrigerator.

# 9 System sizing

## INTRODUCTION

---

For a solar PV system to work properly, the size of the panels and the battery must be matched with the energy needs of the appliances. Because panels and batteries are expensive, people often try to save money by installing too few panels or too small a battery. This is very poor practice and does not really save money, because a system that is too small for the appliances does not work well and the battery will have to be replaced, often at high cost.

Sizing PV systems for homes is not difficult if you know what appliances will be used and how long they will operate each day. Because all the power must come from the solar panels, it is most important that they are large enough to provide the energy needed even on cloudy days.

## CALCULATING THE CORRECT PANEL SIZE

---

The energy used by appliances is measured in watt-hours and the energy produced by the panels is also measured in watt-hours. Watt-hours of energy are like litres of motor fuel. When 5 litres of fuel are needed to go from one place to another, if only 4 litres of fuel are provided the motor will stop before the trip is completed.

The most common reason for the failure of a PV system is that the panels are too small. Designs are usually based on new components used under ideal conditions. As all parts of a PV system degrade over time, the system becomes less efficient and the panels must supply more energy as the system ages.

Because panels that are too small do not charge the battery enough each day, battery life will be shorter than in a system with enough panel capacity. Trying to save money by using panels that are too small results in spending much more on battery replacements over the life of the system. It is usually cheaper to add extra PV panels, because battery life is increased and fewer battery replacements will be needed.

**Example 1**

If a 10 W light is turned on 2 hours a day and a 120 W fan is operated 3 hours a day, how much energy is used by each appliance in one day? What is the total number of watt-hours used by both appliances in one day?

(Light)

$$10 \text{ W} \times 2 \text{ hours} = 20 \text{ Wh/day}$$

(Fan)

$$120 \times 3 = 360 \text{ Wh/day}$$

(Total usage)

$$360 + 20 = 380 \text{ Wh/day}$$

**Example 2**

A 20 W light in a church is used on Wednesday night for 3 hours and Saturday night for 4 hours. The rest of the week it is not used. How much energy will be used each day? What is the daily energy use?

$$20 \text{ W} \times 3 = 60 \text{ Wh on Wednesday}$$

$$20 \text{ W} \times 4 = 80 \text{ Wh on Saturday}$$

So the light uses  $60 + 80 = 140$  Wh per week. There are seven days in a week, so the light uses  $140 \div 7$  or 20 Wh per day, on average.

In a PV system, if an appliance needs 100 watt-hours a day to work properly and if the solar panels only produce 80 watt-hours the appliance will stop working early in the day.

## ELECTRICITY LOSSES

---

If your vehicle's fuel pipe leaks, you will lose fuel as you travel. In a PV system there are always electricity leaks. Even if the panels produce a full 100 Wh a day, this will not be enough to power appliances needing 100 Wh a day because some of the energy from the panels is lost before it reaches the appliances.

In most solar PV systems, the energy from the panels is first stored in a battery before it is sent to the appliances. Some energy is always lost in the battery. So some of the energy provided by the panels never reaches the appliances. Also, a little energy is always lost in the wires and controller even if the wires are the correct size and the controller is working. For every 100 Wh needed by the appliances, the panels must provide at least 130 Wh. The extra 30 Wh are lost in the battery, wires and controller.

### ■ Calculating appliance watt-hours used each day

---

To calculate the number of watt-hours needed each day from the panels, first calculate the number of watt-hours needed each day by the appliances. Then increase the result to cover the watt-hours lost in the wiring and battery before the energy reaches the appliances.

To calculate appliance watt-hours, multiply the number of watts needed to operate each appliance by the number of hours each appliance is used per day.

Always calculate the energy used on a 'per day' basis because the solar panels provide energy on a daily cycle. Sometimes an appliance is used more on some days than on others. For example, the lights in a community centre may only be used on Saturdays and Sundays. In that case calculate the total watt-hours needed per week and divide by 7 to find the watt-hours needed per day.

So far, we have assumed that there is only one appliance. Usually, there are several. You have to find the total energy needed by all the appliances each day. So first find the watt-hours needed per day by each appliance, then add them all together.

### ■ Calculating total watt-hours needed from the panels each day

When you know the daily energy in watt-hours needed by all the appliances, the total watt-hours that the panels must provide each day will be that number of watt-hours plus the watt-hours lost in the wires, battery and controller. A reasonable estimate is that for every 100 Wh used by the appliances, the panels have to produce 130 Wh. Therefore to find the total watt-hours that the panels must provide each day, multiply the total watt-hours used by the appliances by 1.3.

### ■ Estimating the energy output from a solar panel

Photovoltaic panels are made in different sizes. The larger the panel, the more energy in watt-hours it will produce. Panel manufacturers rate the size of their panels by the watts of power that they will produce when the sun is at its peak. This is called panel peak watts.

#### Example 3

A house has three lights. One is 20 W and is used 3 hours a day. The second is 10 W and is used 4 hours a day. The third is 2 W and is used 9 hours a day. What is the total watt-hours used by the three lights in a day?

$$20 \text{ W} \times 3 \text{ hours} = 60 \text{ Wh/day}$$

plus:

$$10 \text{ W} \times 4 \text{ hours} = 40 \text{ Wh/day}$$

plus:

$$2 \text{ W} \times 9 \text{ hours} = 18 \text{ Wh/day}$$

The total energy used is:

$$60 + 40 + 18 = 118 \text{ Wh/day.}$$

#### Example 4

The appliances in a house require 100 Wh per day. How many watt-hours per day must the panels produce?

$$100 \text{ Wh} \times 1.3 = 130 \text{ Wh/day}$$

of which 30 Wh will be lost in the system and 100 Wh used by the appliances.

**Example 5**

A fan uses 200 Wh in a day. How much energy will the panels have to produce each day?

$$200 \times 1.3 = 260 \text{ Wh/day}$$

of which 60 Wh will be lost in the system and 200 Wh used by the fan.

**Example 6**

How many watt-hours would you expect a 55 Wp panel to produce in a typical tropical coastal climate?

$$55 \times 3.43 = 188.65 \text{ Wh/day}$$

**Example 7**

About how many watt-hours per day will a 75 W panel produce in a typical tropical coastal climate?

$$75 \times 3.43 = 257.25 \text{ Wh/day.}$$

On manufacturers' data sheets, panel peak watts are usually shown as Wp. The peak watts produced depend not only on the size of the panel but also on the brightness of the sunlight striking the panel. Therefore, you cannot calculate panel watt-hours by multiplying peak watts by the hours the sun shines, because the brightness of the sun is constantly changing as it moves across the sky and it is only at its peak in the middle of the day. Even at peak sunlight for the day, the brightness of the sun may be reduced by clouds. So a panel will produce less energy in a cloudy climate than in a sunny climate. To estimate the energy produced by a panel you need to consider both the size of the panel and the climate at the location.

Fortunately many measurements have been made of the energy output of solar panels that can be used to estimate their energy production. These measurements were made over many years in a tropical Pacific Island location. They show that it is reasonable to estimate that a 35 Wp solar panel will provide 120 Wh per day on average in a typical tropical, coastal climate such as found in many developing countries. This type of climate rarely has completely clear days, but the clouds are generally scattered and it is unusual to have more than three or four days of continuous cloud. On very clear days the panel will produce more energy, on cloudier days less, but over many days the average daily output from a 35 Wp panel will be about 120 Wh in this type of climate.

If a larger panel is used there will be a larger output of energy. If the panel is twice the size and rated at 70 Wp, it will produce an average of 240 Wh per day, twice as many watt-hours per day than a 35 Wp panel.

## ■ Panel Generation Factor

As the average daily energy produced by a 35 Wp panel in a tropical coastal climate is 120 Wh/day, a tiny 1 Wp panel would provide  $120 \div 35$  or 3.43 Wh/day. If a 1 Wp panel produces 3.43 Wh/day, to find the watt-hour/day from any size of panel all you have to do is to multiply the peak-watt rating of the panel by 3.43. We call this 3.43 factor the Panel Generation Factor for that climate. Every climate has a different Panel Generation Factor. The sunnier the climate, the larger the factor.

## ■ Finding the number of panels needed

If two panels are joined together, twice as many watt-hours will be produced. Three panels will produce three times the watt-hours, and so on. The watt-hours produced are the same whether the panels are connected in series or in parallel.

To find the total peak-watt rating for the PV panels needed to operate the appliances, find the number of watt-hours that the panels must provide and divide by the Panel Generation Factor. For a tropical coastal climate the factor is typically 3.43.

To find the peak-watt capacity that will be needed in a system follow these steps:

**Step 1.** Calculate the watt-hours per day for each appliance used.

**Step 2.** Add the watt-hours needed for each of the appliances to find the total watt-hours per day needed by the appliances.

**Step 3.** Multiply the total appliance watt-hours per day by 1.3 to find the total watt-hours per day that the panels must provide.

**Step 4.** Divide the total watt-hours per day by the Panel Generation Factor for your climate (3.43 is typical).

**Step 5.** Divide the total peak-watt capacity by the peak watts of the panels available to you. This will give you the exact number of panels needed. Usually the result will not be a whole number, but of course you cannot install only part of a panel. You must increase any fractional part of the result to the next whole number to find the number of panels.

### Example 8

A house has the following appliances in use:

One 18 W light used 4 hours per day

One 60 W fan used 2 hours per day

One 75 W refrigerator that runs  
12 hours per day

The system will be powered by 110 Wp panels. How many panels will be needed if the climate is typical tropical coastal (Class 2)?

(Step 1)

Light:  $18 \times 4 = 72$  Wh/day

Fan:  $60 \times 2 = 120$  Wh/day

Refrigerator:  $75 \times 12 = 900$  Wh/day

(Step 2)

Total appliance use =  $72 + 120 + 900$   
= 1,092 Wh/day

(Step 3)

Panel energy needed =  $1.3 \times 1,092$   
= 1,419.6 Wh/day

(Step 4)

Wp of panel capacity needed  
=  $1,419.6 \div 3.43 = 413.9$  Wp

(Step 5)

Number of panels needed =  $413.9 \div 110$   
= 3.76 panels.

Actual requirement = 4 panels.

**Example 9**

A video system that needs 200 W to operate is used 4 hours a week. What Wp of panel capacity will be needed to provide enough energy in a typical Class 2 tropical coastal climate?

$$200 \text{ W} \times 4 \text{ hours} = 800 \text{ Wh/week}$$

$$800 \div 7 = 114.29 \text{ Wh/day}$$

If 114.29 Wh/day are required by the appliances,  $114.29 \times 1.3 = 148.58 \text{ Wh/day}$  must be provided by the panels.

1 Wp of panel can be expected to produce 3.43 Wh/day.

So at least  $148.58 \div 3.43 = 43.3 \text{ Wp}$  of panel capacity will be needed.

**Example 10**

The total appliance watt-hour per day requirement for a house system using a 12 V battery is 260 Wh/day. What total watt-hours must a battery store in order to operate the appliances for 5 days?

$$5 \times 260 = 1,300 \text{ Wh}$$

The number of panels calculated by this method is the *minimum* number. If more panels are installed, the system will perform better and battery life will be lengthened. If less panels are used, the system may not work at all during cloudy periods and battery life will be shortened.

## ADJUSTING THE GENERATION FACTOR FOR DIFFERENT CLIMATES

---

The amount of energy from the panels will be greater than our estimate if the climate is sunnier than a tropical coastal climate. Also, the energy from the panels will be less than our estimate if the climate is cloudier than a tropical coastal climate.

Some climates are seasonal, with many more cloudy days in one season than in another. The size of the system has to fit the cloudiest season if it is to give service all year round. To make a reasonable estimate of the panel output for different climates, you can use the following guidelines:

*Climate Class 1*

Sunnier than the tropical coastal climate with many days of clear skies and few cloudy periods longer than four days. A desert location may be in this class. For this climate, use a Panel Generation Factor of 3.86.

*Climate Class 2*

A tropical coastal climate with most days partly cloudy. Fully cloudy periods are usually no more than five days long. For this climate, use a Panel Generation Factor of 3.43.



*Climate Class 3*

Cloudy periods of five to seven days occur regularly but are typically followed by three or more clear days. For this climate use a Panel Generation Factor of 3.0.

*Climate Class 4*

Cloudy periods of ten or more days occur regularly and fully clear days are unusual. For this climate use a Panel Generation Factor of 2.57.

Remember that you must use the cloudiest season for this calculation even though part of the year the climate may be very clear and sunny. If the system is not sized to allow for the cloudy season, then it will not work properly at that time of year.

## BATTERY SIZE

---

A battery is needed because the appliances use electricity at different times and at different rates than the panels produce. For the system to work properly, the battery should be of the deep-discharge type and be large enough to store enough energy to operate the appliances at night and on cloudy days. Also, for the battery to last a long time, it should not be discharged too much or too often. In sizing a battery, it is important to install one large enough to operate the appliances for at least five days without recharging. In climates that have long periods of cloudy weather, a larger battery may be needed.

**Example 11**

Appliances in a house need 200 Wh/day to operate. How many 40 Wp panels will be needed if the climate is typical Pacific Island?

The panels must produce 200 Wh/day plus the energy lost in the system:

$$200 \times 1.3 = 260 \text{ Wh/day.}$$

The total Wp needed will be:

$$260 \div 3.43 = 75.8 \text{ Wp}$$

Therefore it will take:

$$75.8 \div 40 = 1.89 \text{ panels to do the job.}$$

Therefore at least two panels will have to be installed.

**Example 12**

How many 40 Wp panels will be needed for the conditions in Example 11 if the climate is a Class 3 continental climate?

Panel watt-hours per day must still be 260 Wh/day

The total peak watts must be:

$$260 \div 3.0 = 86.7 \text{ Wp in a Class 3 climate}$$

therefore the number of panels will be:

$$86.7 \div 40 = 2.16 \text{ panels,}$$

so three panels will be needed.



The rule for battery size is to install a battery that has at least five times as much capacity as will be needed to operate the appliances for one day.

### Example 13

A house with a 12 V solar system has the following appliances in use:

One 18 W light used 4 hours per day

One 60 W fan used 2 hours per day

One 75 W refrigerator that runs 12 hours per day

What battery capacity will be needed?

(Step 1)

$$\text{Light: } 18 \times 4 = 72 \text{ Wh/day}$$

$$\text{Fan: } 60 \times 2 = 120 \text{ Wh/day}$$

$$\text{Refrigerator: } 75 \times 12 = 900 \text{ Wh/day}$$

(Step 2)

Total appliance use:

$$72 + 120 + 900 = 1,092 \text{ Wh/day.}$$

(Step 3)

$$\begin{aligned} \text{Total appliance watt-hours} \times 5 &= 1,092 \times 5 \\ &= 5,460 \text{ Wh} \end{aligned}$$

(Step 4)

Divide watt-hours by battery voltage

$$5,460 \div 12 = 455 \text{ Ah}$$

So, for the house in the example, a deep-discharge battery of at least 455 Ah should be used.

Remember that battery life depends on how much discharge takes place before a recharge. So another way of sizing a battery is that the battery should be large enough so that one day's use of the appliances will discharge it no more than one-fifth of its full charge. This limited discharge before recharging will help the battery to last a long time.

When buying a battery, the voltage and the ampere-hour rating must be known. For a solar PV system in a home the voltage will usually be either 12 V or 24 V. The size in ampere-hours will depend on the energy requirements of the appliances.

As the battery should store five times the energy that the appliances use in one day, the watt-hour capacity needed in the battery is the total appliance watt-hours per day times 5.

Because manufacturers rate their batteries in ampere-hours, not watt-hours, you need to convert the calculated watt-hours to ampere-hours. As watts equals volts times amperes, dividing watt-hours by the battery voltage gives ampere-hours.

When you know the total watt-hour capacity of the battery, you can calculate the ampere-hour capacity by dividing watt-hours by the battery voltage:

$$1,300 \text{ Wh} \div 12 \text{ V} = 108.33 \text{ Ah.}$$

For this example, the battery chosen should be a 12 V deep-discharge battery with at least a 108.33 Ah rating.

For these calculations, we are assuming a battery rated at  $C_{10}$  discharge rate, not  $C_{100}$ . If the battery manufacturer rates batteries at  $C_{100}$ , you will need to increase the size of the battery you buy by multiplying the  $C_{10}$  calculated value by 1.3 to get the  $C_{100}$  capacity battery to install.

Remember that if a deep-discharge battery cannot be found and you have to use a vehicle starting battery, it is best to choose one with at least twice the ampere-hour capacity than would be correct for the deep-discharge battery. Even then, it will probably not last as long as a deep-discharge battery. A 'maintenance-free' battery that does not allow access to the cells for water replacement should be about 1.5 times larger than would be correct for a deep-discharge battery.

### ■ Summary of battery size calculations

---

**Step 1.** Calculate the watt-hours per day used by each appliance.

**Step 2.** Total the watt-hours per day used by all appliances.

**Step 3.** Multiply the total appliance watt-hours per day by 5 for a deep-discharge battery, multiply by 7.5 for a maintenance-free battery or multiply by 10 for a vehicle battery.

**Step 4.** Divide the result of Step 3 by the battery voltage. The result will be the required ampere-hour capacity of a deep-discharge battery at a  $C_{10}$  discharge rate. If the battery you want to use has the ampere-hour capacity rated at the  $C_{100}$  discharge rate, you need to multiply the calculated ampere-hour size by about 1.3. So if you calculate the  $C_{10}$  rate as 100 Ah, you need to buy a battery with a rating of at least 130 Ah at  $C_{100}$ .

Too small a system will run out of power when the weather is cloudy and will cause batteries to fail more often. Whenever a PV system is not working properly, always check to make sure that the panels and battery are large enough to provide the watt-hours needed to operate the appliances each day.

If the system is too small, you *must* either increase the number of panels or reduce the energy needed by the appliances, by using fewer appliances or using them for a shorter time.

A larger battery may also be needed, but installing a larger battery without first installing more panels will not help. If you do not increase the number of panels, the system will continue to work poorly and the battery life will remain short.

In calculating the ampere-hour capacity of a battery, use the actual watt-hours needed by the appliances, not 1.3 times that amount as with the panels. There is some loss of energy between the battery and the appliances but this is small enough to ignore in calculating battery size.

### **Battery sizing calculation**

**Step 1.** Calculate the watt-hours per day used by each appliance.

**Step 2.** Total the watt-hours per day used by all appliances.

**Step 3.** Multiply the total appliance watt-hours per day by five.

**Step 4.** Divide the result of Step 3 by the battery voltage. The result will be the required ampere-hour capacity of a deep-discharge type battery at a  $C_{10}$  discharge rate.

If a vehicle battery is to replace a deep-discharge battery, the vehicle battery should have about twice the ampere-hour capacity as the deep-discharge battery if it is to last a reasonable time.

## **SYSTEM MODIFICATIONS AND SIZING**

---

The size of the panels and the battery are both determined by the watt-hours used by the appliances. The number of watt-hours changes when appliances are added or removed from the system and when appliances are used more or less each day. If you have more panels and a larger battery than you need, it is not a problem. It is a problem, however, when the panels or battery are too small. People often want to add appliances to an existing PV system. If they do, the system will not work properly unless the panels and battery are large enough to provide the extra watt-hours. Whenever a new appliance is added, or an old appliance replaced by a new one, it is important to recalculate the correct panel and battery sizes and to increase the system capacity to handle any increased load.

It is also common for people to underestimate the amount of time that lights and other appliances will be used. If the PV system size is calculated using estimates of appliance use that are too low, then the system will not be powerful enough and will not work well.

## **BATTERY LIFE AND PANEL SIZE**

---

It has been shown that increasing the panel size increases battery life, particularly in a climate with frequent cloudy conditions. With the cost of solar panel capacity falling

but the cost of batteries slowly increasing, it makes good economic sense to increase the panel size by 20% to 30% over the minimum. This can dramatically improve the reliability of the system during cloudy weather and can greatly extend the life of the battery. This reduces the cost over time as battery replacements are now the most expensive component in a home PV system.

## CONTROLLER SIZE

---

The charge controller has to have enough ampere capacity to pass the maximum current that the panels can provide. This can be estimated by dividing the peak-watt rating of the panels by 12 V. So a controller connected to a 100 Wp panel should have a charging capacity of at least  $100 \div 12 = 8.33$  A.

Most appliances need more amperes to start than to keep running. Electric motors in particular may need three times as much current to start as they need to keep them running. So the discharge controller must have enough ampere capacity to pass the maximum load current, including the extra starting current. The minimum ampere capacity of a discharge controller should be equal to the sum of the amperes from all appliances without motors times 1.5, plus the amperes from all appliances with motors times 3. For example, four lights of 12 W capacity

The accuracy of any PV system design depends on the accuracy of estimates of appliance use. Estimates are rarely very good in the long term. People often underestimate the amount of time that appliances will be used. This results in more energy being used than the system was designed for.

People may also add more appliances to an existing PV system. This increases the amount of energy needed and the system is then too small.

The best way to make sure that sufficient panel and battery capacity is available is to keep checking the system and if the panels consistently supply too little energy, as shown by frequent power cuts or a low average battery charge, then more panels and possibly a larger battery should be installed.

**Example 14 - controller sizing**

Charge controller:

A 24 V PV system includes 300 Wp of panels.  
What size charge controller is needed?

Divide the panel peak watts by the system voltage to find the charge controller amperes:

$300 \div 24 = 12.5$  A minimum charge controller capacity at 24 V

Discharge controller:

The above PV system operates:

Four 18 W fluorescent lights

One 60 W refrigerator

One 35 W television

What size discharge controller is needed?

$18 \text{ W} \div 24 \text{ V} = 0.75$  A per light

$35 \text{ W} \div 24 \text{ V} = 1.46$  A for the television

$4 \times 0.75 + 1.46 = 4.46$  A running current

$4.46 \times 1.5 = 6.7$  A for starting

For the refrigerator:

$60 \text{ W} \div 24 \text{ V} = 2.5$  A

$2.5 \text{ A} \times 3 = 7.5$  A for starting

So the discharge controller should be rated at least  $6.7 + 7.5 = 14.2$  A at 24 V

have a total operating load of 4 A. So the controller should have a capacity of at least  $4 \text{ A} \times 1.5 = 6$  A. If a motor that needs 3 A to run is added to the load, the controller capacity should be increased by another 9 A ( $3 \text{ A} \times 3$ ) to give a total capacity of 15 A.

## CONCLUSION

---

Although a smaller system may be cheaper at first, it is often more expensive in the long term. Trying to save money by installing too few panels or too small a battery only leads to an unreliable system with a high maintenance cost.

# Maintenance

# 10

## INTRODUCTION

---

For something to last a long time and work properly, it must be cared for. A house, a boat, even your own body, will last longer and perform better if it is well looked after. This continuing care is called maintenance. Solar PV systems also require continuing maintenance if they are to last a long time and work well.

It is always better to stop a boat from leaking by regular care instead of waiting until it sinks. With a solar PV system, it is much better to check everything regularly and to fix small problems before they become large ones. Although maintenance includes repair of the system, it is better to keep systems from breaking down than to just do maintenance when something is broken. The kind of maintenance that prevents problems is called preventive maintenance and this is what is described for PV systems in this chapter.

Because preventive maintenance for PV systems is so simple and so little seems to be done at each visit, it may seem unimportant. It is not unimportant. Small problems, like little cracks in a boat hull, soon become large problems if not taken care of. By doing regular maintenance you may avoid a major repair later.

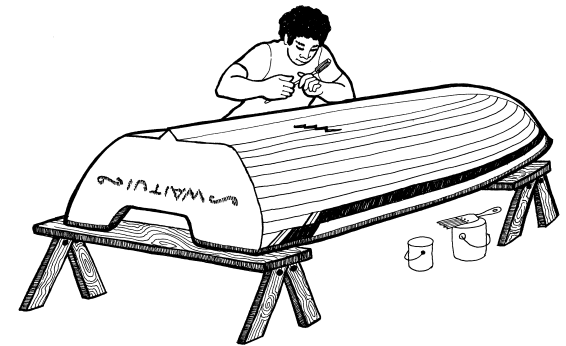

It does not take much time and money to regularly maintain a solar PV system but it may take a lot to repair the system if it fails. Regular maintenance makes the difference between a PV system that works without problems for years and one that is always breaking down.

Most failures in PV systems happen slowly. Poor maintenance usually shortens the life of the battery rather than causing sudden failure.



It is very important to keep complete records of maintenance. Many problems with solar PV systems happen slowly so, without proper records, problems may not be noticed until it is too late to fix them easily.

Records of battery hydrometer and voltage readings are particularly important. They should be checked and written down at every visit.

Records of repairs and of changes to the system are also important.

## REGULAR MAINTENANCE

- 1) Ask the user about the operation of the PV system to see if there are any problems.

*The user of the PV system is most familiar with how well it works. Just as when you are falling sick, you notice changes in the way your body works, when a PV system is starting to have problems, the user will notice changes in the way it works. When the user notices such changes, it is time to do a careful check of the system. Even if you find nothing wrong, always write down what changes the user has noticed so that if a problem does develop you have a record of how it started.*

- 2) Check every part of the PV system for correct operation, cleanliness and tight connections.

*Problems with any part of the system will cause the entire system to work poorly. In particular, problems with wiring, panels or the controller can damage the battery and greatly shorten its life. Dirt and corrosion always cause problems with electrical equipment. Connections that are loose or corroded will also cause problems. Every part should be checked at every maintenance visit.*

- 3) Repair or replace components that are not in good condition.

*If a component is not working properly, it must be immediately repaired or replaced with a good one. Otherwise the system will not work well and other components, particularly the expensive battery, may be damaged.*

- 4) Check the system to make sure that no changes have been made that have not been authorized.

*A user may have added more appliances to a solar PV system. Because the system has been carefully designed around the original set of appliances, adding any new appliances will cause problems and shorten the battery life. If more appliances are required, enough additional panels and a large enough battery **MUST** be*



*installed at the same time as the new appliance otherwise the system will soon fail.*

- 5) Make a record of any action taken during the maintenance visit.

*Problems with PV systems often develop slowly. If careful records are kept, it will be much easier to see what repairs are needed when the system finally does break down. Also, a record of maintenance activities will show if any particular components are not working the way they are supposed to and better components can be chosen in future.*

## RULES FOR MAINTENANCE

To be useful, maintenance must be carried out on a regular basis. A monthly check is best for batteries, though a very thorough check of all components should be done at least every six months.

### ■ Panels

1. Check the panel mounting to make sure that it is strong and well attached. If it is broken or loose, repair it.
2. Check that the glass is not broken. If it is, the panel will have to be replaced.
3. Check the connection box to make sure that the wires are tight and the water seals are not damaged.
4. Check to see if there are any shade problems due to vegetation or new building. If there are, make arrangements for removing the vegetation or moving the panels to a shade-free place.

### ■ Wires

1. Check the wire covering (insulating sheath) for cracks or breaks. If the insulation is damaged, replace the wire. If the wire is outside the building, use wire with weather-resistant insulation.



Check panels regularly for dirt, shade, tight connections and secure mounting.

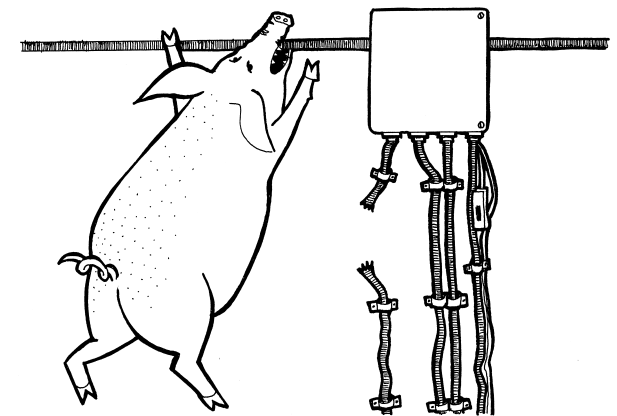

Pigs, mice, rats, dogs, birds and insects have all been known to cause damage to PV system wiring and components. Always visually check all wires and components for damage and insect nests.

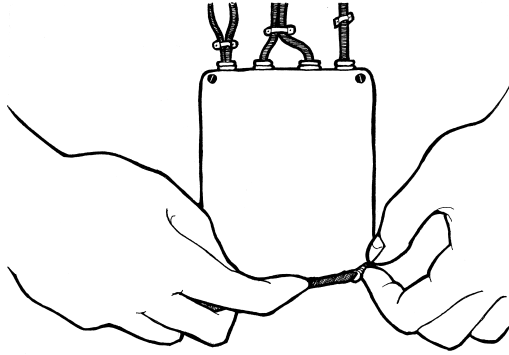

Controllers must be checked for loose wires and secure mounting. They should be opened and checked for cleanliness and insects.

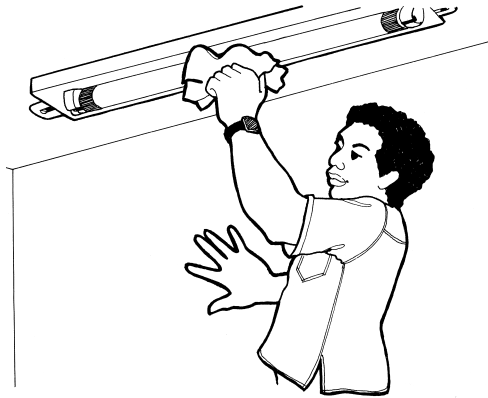

One of the most important maintenance tasks is cleaning all components. PV systems work better and longer if they are kept clean.

2. Check the attachment of the wire to the building to make sure that it is well fastened and cannot rub against sharp edges when the wind blows.
3. If someone has changed the wiring since the last check, make sure that it is the correct size, that it has suitable insulation, that the connections are properly made and that it is fastened securely in its new place.
4. If someone has added more wires to the PV system to operate additional appliances, advise the owner that this may seriously lower the reliability of the system. Advise increasing the panel and battery capacity to handle the increased load.
5. Check the connections for corrosion and tightness.

### ■ Controller

---

1. Check that the controller is still firmly attached. If it is not, attach it correctly with screws.
2. Keep the controller clean.

### ■ Appliances

---

1. Turn on each appliance and check that it is working properly.
2. Check that appliances are mounted securely. If loose or incorrectly mounted, attach them securely.
3. Clean all exposed parts of each appliance. Clean light bulbs and plastic covers.

### ■ Maintenance-free battery

---

1. Check connections for tightness and corrosion. Clean and tighten as needed. Cover connections with heavy grease. Do not get the grease on any part of the battery except the connections.
2. Clean the battery with fresh water and a rag.

### ■ Open-cell battery

---

1. Clean the top of the battery. Check connections for tightness and corrosion. Clean and tighten as needed.

2. Check each cell with a hydrometer and record the readings. When checking take off one cap at a time. Do not remove all caps at once because that greatly increases the risk of dirt getting into the cells.
3. If any cells are low on water, add distilled water to raise to the correct level. Never add more acid, only water. If distilled water is not available, carefully collected rainwater can be used. Remember that any salt, minerals or oil in the water will poison the battery and shorten its life, so be very careful about collection and storage of water for the battery.
4. If any of the caps for the cells have been lost or broken, cover the fill holes loosely with plastic or glass until proper replacement caps are available. Never cover the holes with paper, cork, cloth or metal. Never leave the holes uncovered. Be careful that the temporary cover that you install does not plug the holes tightly because the cells must have air.
5. Clean the battery with fresh water and a rag.

### ■ Maintenance records

As long as a solar PV system is working well, maintenance records have little value but they become very important when something goes wrong. By looking at the maintenance records it is often possible to immediately see what is wrong with a system. It is also possible to see problems developing with batteries and appliances by looking at well-kept maintenance records. Maintenance records are also proof that you have taken good care of the system. Records are kept on a card or small notebook located at each PV system. When the system is first installed, the manufacturer's name, model number, serial number and characteristics of every component should be recorded. A diagram of the electrical circuit showing the connecting wire size should be made.

At each maintenance visit, the date of the visit and a brief description of any problems and work done should be written down. If the battery is of the open-cell type, record the hydrometer readings of each cell and note which cells need water. Any repairs or changes to the system should be recorded. If new components are added, their manufacturer, model and serial number should be recorded. If a change is made in the electrical circuit, record the change on the circuit diagram.

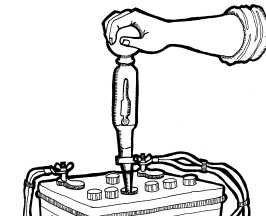

Hydrometer readings for each cell of a battery should be made at every visit. Each reading should be written down along with the date and time. If problems occur in the system, the record of these readings will be very valuable in finding and repairing the source of the trouble.

Batteries should be kept clean. Dirt on top of the battery may fall into the cells while adding water. Energy could also be lost from the battery because a small current could flow through the dirt between the connections.



Maintenance records should be made at the time of the visit. It is not a good idea to wait until later to write down what you did. You should keep one copy of the maintenance records for yourself and leave another copy at the site in a water-resistant package.

Clean components work better and last longer. One of the most important maintenance activities is cleaning the battery, the controller, the appliances and the panels.

## **SPECIAL MAINTENANCE WHEN REPLACING A BATTERY**

---

Never install an expensive new battery in a PV system that is not working perfectly. When the battery is replaced, the entire system should be carefully checked and generally overhauled. Take apart and clean all the connections, then reconnect them correctly. Check the operation of all the appliances and the controller. Generally make sure that the system is brought back to a new condition.

# Troubleshooting and repair

## INTRODUCTION

---

Well-designed, well-installed and well-maintained solar PV systems are reliable and can have a long trouble-free life, but sooner or later there will be a failure. The process of finding the cause of the failure is called troubleshooting. The process of making the system work properly again is called repair.

### ■ Types of System Failure

---

There are three types of solar PV system failure:

#### **Failure type 1**

The system stops working entirely. None of the appliances work.

#### **Failure type 2**

Some appliances work normally, others do not.

#### **Failure type 3**

The system works but runs out of power too quickly.

Each type of system failure has a different cause and troubleshooting methods are different.

### **TROUBLESHOOTING RULE 1**

**KNOW HOW THE SYSTEM IS SUPPOSED TO WORK**

Problems with PV systems may be due to their components or to outside effects such as shade, unusually long periods of cloudy weather or excessive use of appliances.

Unless you know how each component performs when operating correctly, you cannot be sure whether the problems come from inside or outside the system.

When the system is installed, a record should be made of the installation and the operating characteristics of all components. This should include at least a complete wiring diagram, notes on hours of shade, the number of amperes required to operate each appliance, the set points of the controller, and the amperes and volts available from the panels at noon on a clear day.

## TROUBLESHOOTING RULE 2

### KNOW HOW TO USE YOUR TEST EQUIPMENT AND TOOLS

Electricity is invisible and what is happening in an electrical system can only be understood from the use of electrical test equipment.

The most important test tool is a good quality meter for measuring voltage, current and resistance. If you do not fully understand how to use all the controls and features of your meter, study the instructions, get help from somebody who knows and then practise measuring.

Test equipment is useless if it is not working properly. Whenever there is doubt about the accuracy of a meter, it should be checked. In any case, any internal batteries should be replaced and a meter should be fully checked for correct operation and accuracy at least once a year.

## FAILURE TYPE 1: TOTAL SYSTEM FAILURE

If the system fails completely, the reason is usually a broken wire, poor connection or controller failure. The problem is to isolate the fault in the system. First check the battery charge using a hydrometer or voltmeter.

### ■ Discharged battery

If the battery is discharged and does not charge when the appliances are switched off for several days, the fault lies between the battery and the panel.

1) **Fuse or circuit-breaker problem.** Make sure that all appliances are switched off. Check any fuse or circuit-breaker in the panel to battery circuit.

***Corrective action:** Disconnect the loads at the controller. If the fuse is blown, replace it with the correct type and ampere capacity of fuse. If the circuit-breaker is tripped, turn it back on. See if the battery will charge. If the fuse or circuit-breaker blows again or the battery will not charge, there is a problem with the wiring between the panel and battery or with the controller. Continue with this checklist. If the fuse or circuit-breaker does not blow, reconnect the load and turn the appliances on. If the fuse or circuit-breaker blows again, there is a short in the appliance wiring or in an appliance. See the checklist for failure type 2.*

2) **Faulty panel or panel wiring.** Disconnect the leads to the panel terminals of the charge controller. Check the voltage across the two wires from the panel when the sun is shining. If the voltage is less than 12 V, there is a problem with the panel or the panel wiring. If the voltage is 12 V or more, measure the amperes from the panel. If the amperes are very low for the panel that is installed, the connections to the panel may be loose or corroded. Also the panel may be damaged.

***Corrective action:** Disconnect all the panels and carefully check that each one is working properly (voltage and amperage). Replace panels that are not working well. Clean all terminals and wires. Reconnect the panels, making sure that the correct*

wires are connected to the correct terminals. Also make sure that the panels are not shaded.

3) **Battery failure:** Check all cells of the battery with a hydrometer. If one or more cells are very different from the other cells, there is a battery problem. A damaged cell will often have cloudy electrolyte or a white scum on the electrolyte. If the cell readings are about the same but very low, or if you have a sealed battery, connect the panel directly to the battery for several sunny days to see if the battery will fully charge. If it will charge, reconnect the battery to the system and check the operation of other parts of the system.

**Corrective action:** *If the battery shows damage or will not charge from the panel, replace the battery and check the panels, controller and wiring. Disconnect, clean and reconnect all connections. If the battery will charge directly from the panel, continue with the following checks.*

4) **Faulty controller.** Check the voltage at the battery connections and the panel connections on the controller when the sun is shining. If the voltage at the battery connection is less than 13.5 V and the voltage at the panel connection is more than 14 V, the controller has probably failed. Some types of complex, computerized controllers cannot be tested with simple voltmeters. If that type of controller is thought to have failed, you have to replace the controller with one known to work properly and wait to see if that cures the problem.

**Corrective action:** *Replace the controller.*

5) **Faulty wiring between controller and battery.** With the battery charged, turn on all the appliances. Measure the voltage at the battery terminals of the controller and the voltage directly on the terminals of the battery (not on the battery connections, but on the actual terminals of the battery itself). If the voltage is more than 0.5 V lower at the controller than at the battery terminals, there is a wiring problem.

**Corrective action:** *Disconnect all wires, remove connectors from battery terminals. Clean all connections and wires. Replace wires in connectors and terminals and tighten all connections. Make sure that the wire connecting the controller and the battery is the correct size for the current being carried.*

### TROUBLESHOOTING RULE 3

WHEN A BATTERY IS REPLACED ALWAYS CHECK THAT ALL OTHER COMPONENTS ARE WORKING PROPERLY

A battery failure usually happens slowly and is the result of a long series of small changes. These changes may be caused from inside the battery due to age or adding impure water, or from outside the battery.

Outside problems can result in damage due to over-discharging the battery, leaving it partially charged for a long time, or strongly overcharging it. These problems may be caused by:

- overuse
- too much shade
- poor design
- incorrect installation
- faulty wiring
- faulty appliances
- faulty controller
- faulty panel

**TROUBLESHOOTING RULE 4**

KEEP COMPLETE RECORDS OF MAINTENANCE AND REPAIRS AND USE THEM

A complete set of records should be kept from the day of installation and they should be checked whenever the system has problems and you need to troubleshoot.

In using the records, you should check particularly for:

- changes in wiring to make sure connections and wire sizes are correct
- changes in shading from vegetation growth
- battery cells that usually measure higher or lower than the rest of the cells
- battery cells that take more water than normal
- battery charge levels regularly lower than other batteries in similar systems that were checked at about the same time
- previous repairs to fix a similar problem.

**■ Charged battery**

When the battery is charged but the appliances do not work, there is a wiring fault between the battery and the appliances.

1) **Fuses or circuit-breakers.** Check all fuses and circuit-breakers. If they have opened the circuit there is a short circuit in the wiring or appliances. Check all appliances and the wiring from the controller to the appliances.

***Corrective action:** Fix shorted wiring or faulty appliances, replace fuses and reset circuit-breakers.*

2) **Wiring between controller and appliances.** Turn on at least one appliance and check the voltage at the load connections on the discharge controller. If the load voltage is about equal to the battery voltage, the fault is in the wiring between the controller and the appliances.

***Corrective action:** Clean all connections, replace all wires that are damaged or that are not the correct size for their length.*

3) **Faulty switch.** If there is one switch that controls all appliances, it may be the problem. Using a short wire, connect across the switch terminals. If the appliances work, then the switch is faulty.

***Corrective action:** Replace the switch.*

4) **Controller failure.** Measure the voltage at the load terminals and at the battery terminals of the controller. If the load terminal voltage is zero or much lower than the battery terminal voltage, the discharge controller may not be working properly.

***Corrective action:** Replace the controller.*



## FAILURE TYPE 2: SOME APPLIANCES WORK BUT SOME DO NOT

---

This type of failure is rarely due to PV panel or battery failure. It may be caused by:

1) **A faulty appliance switch.** Use a short wire and connect the switch terminals together. If the appliance works, the switch is faulty.

*Corrective action:* Replace the switch.

2) **An appliance has been wrongly connected.** Check the connection at the appliance. Make sure that the + wire of the appliance is connected to the + wire of the controller.

*Corrective action:* Connect the wires correctly.

3) **An appliance is faulty.** Check the battery voltage. If the battery voltage is low, there may be a controller problem. If the voltage is over 12 V, use a new wire of the correct size and connect the appliance directly to the battery. If the appliance does not work, it is probably faulty.

*Corrective action:* Repair or replace the appliance.

4) **The discharge controller is not working properly.** Check the battery voltage. If it is below 11 V, the discharge controller may be faulty.

*Corrective action:* Replace the controller and advise the user not to use the appliances for longer than the system is designed for.

Solar panels rarely fail. Unless something on the panel is broken, problems caused by low output are usually caused by shade, poor connections, incorrect wiring or faulty orientation of the panel.



Shading can be seasonal. Because the sun moves north and south in the sky over the year, trees that do not shade panels at one time of the year may shade them months later. Always check for possible shade problems to the north and south of the panels as well as to the east and west.



It is common for relatives who live in the city to bring appliances to family and friends who have PV systems. Using these extra appliances may cause the system to run out of energy too soon and seem to need repair, when in fact it is just being overused. If more appliances are to be used, more panels and a larger battery may have to be installed.



Except for cleaning and fixing poor connections, a controller cannot be repaired on site. If faulty, it must be replaced.

5) **The wire size is too small or too long.** Measure the length of the wire run. Check to see if the wire is too small for its length.

*Corrective action:* Replace the wire with one of the correct size.

6) **Connections are loose or dirty.** Remove wires from all connections between the appliance and the controller. Clean the wires and terminals. Replace the wires and tighten the connections.

### FAILURE TYPE 3: THE SYSTEM WORKS BUT RUNS OUT OF POWER

This is the most common problem with solar PV systems and can be caused by many things acting alone or in combination.

This type of failure shows that there is not enough charge in the battery to operate the appliances as long as the user requires. This may be caused by:

1) **Too little charge from the panels.** The reason for this may be shading, damaged panels, wiring too small or too long, dirty or loose connections, panels not facing in the right direction or dirt on the panels.

*Corrective action:* Remove the cause of the shade or move the panels so they are no longer shaded and are facing in the right direction, clean and replace the panels if damaged, check the wiring on the panels.

2) **Adding more or larger appliances to the system.** This takes more energy from the battery than the system was designed for and discharges the battery too quickly.

*Corrective action:* Add more panels and increase the battery capacity, or remove the extra appliances.

3) **Operating the appliances longer than originally intended.** This takes more energy from the battery than the system was designed for.

*Corrective action:* Add more panels and increase the battery capacity, or the user must reduce the time appliances are used to the original level.

4) **Incorrect adjustment of the charge controller.** This may prevent the battery from fully charging. In some cases a special controller tester will be available but, when it is not, you can check by asking the user to keep appliance use to a minimum for several sunny days so that the battery will fully charge. Come to the site in the late afternoon of the third or fourth sunny day while the sun is still shining. Check the voltage at the battery terminals and at the panel terminals of the controller. If the two voltages are about the same and they are both above 13 V for a 12 V system, or 26 V for a 24 V system, then the charge controller is probably working properly. If the panel voltage is several volts higher than the battery voltage, and the battery voltage is less than 12.8 V for a 12 V system or 25.6 V for a 24 V system, then the charge controller may be disconnecting the system too soon and not allowing the battery to fully charge. For some types of complex, computerized controllers these simple voltage tests do not work. If that type of controller is installed and is suspected of having failed, you can only replace the controller with one known to work then wait to see if the system performs properly.

*Corrective action:* Replace the controller and send the old one for repair.

5) **Incorrect adjustment of the discharge controller.** This disconnects the appliances from the battery before the maximum charge has been taken from the battery.



Whenever a battery has to be replaced, check every part of the PV system, including all wiring, to make sure that everything is working properly. Otherwise the new battery may have its life shortened because some other part is faulty.



When you replace a battery, try to find the same type and size as the one installed in the PV system when it was new.

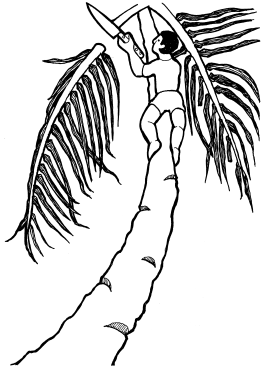

A common reason for a PV system running out of electricity is increased shade from trees that have grown since the system was installed. For the system to work properly, the trees should be trimmed, the panels moved to a sunnier spot, or more panels installed to make up for the smaller amount of sunshine hitting the panels.

For some types of panel, shade on just one or two cells can greatly reduce panel power. Remember that a small amount of shade on a panel can be a serious problem.

If the battery shows more than half its fully charged voltage when the appliances go off, the discharge controller is probably out of adjustment.

**Corrective action:** *Replace the controller and send the old one for repair.*

6) **The battery is getting weak and can no longer store enough charge to operate the appliances for long.** This can be checked by a battery ampere-hour capacity test. The battery is likely to be the problem if one or more cells show readings very different from the others or if the battery is more than four years old. If the battery is less than four years old, its failure may have been caused by another problem in the system. Whenever a battery less than four years old must be replaced, check the rest of the system very carefully. Make sure that the panels are not shaded part of the day and that the user is not trying to take more energy from the system than it was designed to deliver. All these things may have seriously shortened the life of the old battery and if allowed to continue will ruin the new battery as well.

**Corrective action:** *Replace the battery but monitor the replacement carefully. If after the first month the system once again does not seem to be providing energy as long as expected, one or more of the other five reasons for failure exists and must be corrected, otherwise the new battery will also rapidly weaken and fail.*

## BATTERY REPLACEMENT

---

People who do not understand the way a solar PV system works often replace the battery whenever the system is not working well. Sometimes there was nothing

wrong with the old battery and in a few days or weeks the system again stops working. Sometimes the battery has failed because of another problem and replacing the battery with a new one will make the system work for a while, but unless the other problem is fixed the new battery will soon fail.

The battery is not only the most expensive part of a PV system, it is also the part most easily damaged. Whenever you have to replace a battery, especially if that battery is less than four years old, always check the other components to see if they are working properly and always check to see if the appliances are being used as originally intended.

Most early battery failures can be traced to either too much shade on the panels or too few panels in the installation. If shading is not a problem, the system size may be too small for the load being applied. In any system where the batteries seem to wear out too quickly, check the adjustment of the controller and, if that is correct, more panels should be added and a larger battery installed at the next replacement.



A PV system and a rainwater system work in very similar ways. If you have difficulty in understanding a PV system, think of how a rainwater system works and it may help you to see what is happening in the PV system.

# Glossary

<i>alternating current (ac)</i>	current constantly changes direction
<i>Ampere (A)</i>	electrical flow rate (intensity or current)
<i>ampere-hour (Ah)</i>	amperes times hours, a measure of electrical volume
<i>battery</i>	a cell or group of cells used to store electricity
<i>charge</i>	fill a battery with electricity by passing a current through it
<i>circuit-breaker</i>	switch that automatically interrupts an electrical circuit when something goes wrong
<i>compressor</i>	device that raises the pressure of a gas
<i>condenser</i>	device that converts gas into liquid
<i>conductor</i>	material that lets an electric current flow through it easily (the opposite of an insulator)
<i>controller</i>	electrical valve to control the amount of electricity going into or out of a battery
<i>Coulomb (C)</i>	electrical volume
<i>current</i>	flow of electricity, measured in amperes (A)
<i>direct current (dc)</i>	current always flows in one direction
<i>discharge</i>	release electrical energy from a battery
<i>electrical load</i>	measure of power needed by an appliance or group of appliances, in watts (W)
<i>electrolyte</i>	liquid used in storage batteries
<i>energy</i>	amount of work done, measured in watt-hours
<i>evaporator</i>	device that converts liquid into gas
<i>fluorescent light</i>	lamp that gives cold light from glowing material inside the tube
<i>fuse</i>	safety device that melts to interrupt an electrical circuit if it is overloaded

<i>gauge</i>	measuring instrument
<i>Hertz (Hz)</i>	measure of frequency of alternating current
<i>hydrometer</i>	instrument for measuring the weight of a liquid compared with water
<i>incandescent light</i>	lamp that gives light when the thin wire inside is heated by an electric current
<i>insulator</i>	material that does not let an electric current flow through it easily (the opposite of a conductor)
<i>inverter</i>	device to convert direct current into alternating current
<i>kilogram (kg)</i>	measure of weight or mass
<i>kilowatt-hour (kWh)</i>	1 kWh = 1000 Wh (see <i>watt-hour</i> )
<i>litre (l or L)</i>	measure of volume (liquid)
<i>metre (m)</i>	measures of length
<i>centimetre (cm)</i>	
<i>millimetre (mm)</i>	
<i>ohm (<math>\Omega</math>)</i>	electrical resistance to flow
<i>parallel</i>	joining components in an electrical circuit so that each component is on a different branch of the circuit with no current flow in common
<i>peak watts (Wp)</i>	watts of power that solar panels will produce under optimum conditions of strong sun and cool temperatures (the greatest amount that can be produced by a panel)
<i>photovoltaic (PV)</i>	process that uses sunlight to make electricity
<i>power (W)</i>	ability to do work
<i>pressure</i>	force
<i>refrigerant</i>	material that circulates inside a refrigerator to move heat from inside the refrigerator to the outside air

<i>semiconductor</i>	material that lets an electric current flow through it less easily than a conductor, but more easily than an insulator (used to make transistors)
<i>series</i>	joining components in an electrical circuit so that the whole current passes through each component without branching
<i>short-circuit</i>	faulty or accidental connection in an electrical circuit
<i>square centimetre (cm<sup>2</sup>)</i> <i>square millimetre (mm<sup>2</sup>)</i>	measures of area
<i>transistor</i>	device to control the flow of electricity
<i>Volt (V)</i>	electrical pressure (electromotive force)
<i>volume</i>	measure of the amount of space occupied by something
<i>Watt (W)</i>	electrical power
<i>watt-hour (Wh)</i>	watts times hours, a measure of energy